

GE  
Sensing & Inspection Technologies

## Pressure Automated Calibration Equipment

User manual K0443

### PACE5000



### PACE6000





## **Introduction**

This technical manual provides operating instructions for the PACE Pneumatic Pressure Controllers.

**The features shown and described in this manual may not be available on some models.**

## **Safety**

The manufacturer has designed this equipment to be safe when operated using the procedures detailed in this manual. Do not use this equipment for any other purpose than that stated.

This publication contains operating and safety instructions that must be followed to ensure safe operation and to maintain the equipment in a safe condition. The safety instructions are either warnings or cautions issued to protect the user and the equipment from injury or damage.

Use suitably qualified \* technicians and good engineering practice for all procedures in this publication.

## **Pressure**

Do not apply pressures greater than the maximum working pressure to the equipment.

## **Toxic Materials**

There are no known toxic materials used in construction of this equipment.

## **Maintenance**

The equipment must be maintained using the procedures in this publication. Further manufacturer's procedures should be carried out by authorized service agents or the manufacturer's service departments.

## **Technical Advice**

For technical advice contact the manufacturer.

\* A qualified technician must have the necessary technical knowledge, documentation, special test equipment and tools to carry out the required work on this equipment.

## Abbreviations

The following abbreviations are used in this manual; the abbreviations are the same in the singular and plural.

abs	Absolute
a.c.	Alternating current
ALT	Altitude
BSP	British pipe thread
CAS	Calculated airspeed
CSK	Countersunk
d.c.	Direct current
DPI	Digital Pressure Instrument
e.g.	For example
etc.	And so on
Fig.	Figure
ft	Foot
g	Gauge
Hg	Mercury
HTS	High tensile steel
Hz	Hertz
IAS	Indicated airspeed
i.e.	That is
IEC	International Electrotechnical Commission
IEEE 488	Institute of Electrical and Electronic Engineers standard 488 data
in	Inch
kg	Kilogram
kts/kn	knot
LCD	Liquid crystal display
m	Metre
mA	Milliampere
max	Maximum
mbar	Millibar
min	Minute or minimum
mm	Millimetre
mV	Millivolts
MWP	Maximum working pressure
No.	Number
NPT	National Pipe Thread
PACE	Pressure Automated Calibration Equipment
Para.	Paragraph
PDCR	Pressure transducer
PED	Pressure Equipment Directive
psi	Pounds per square inch
PTX	Pressure transmitter

ROC	Rate of Climb
RS232	Serial communications data standard
SCPI	Standard Commands for Programmable Instruments
UUT	Unit under test
V	Volts
VFC	Volts-free contact
+ve	Positive
-ve	Negative
°C	Degrees Celsius

## Associated publications

K0447 PACE 5000/6000 User Guide and Safety Instructions  
 K0450 PACE Series Calibration Manual  
 K0476 Pressure Control Module User Guide and Safety Instructions  
 K0472 Remote Communications Manual  
 K0469 Heritage Communications Manual - Instrument Emulation

## Symbols

The equipment contains the following symbols to identify hazards.



This equipment meets the requirements of all relevant European safety directives. The equipment carries the CE mark.



This symbol, on the instrument, indicates that the user should refer to the user manual.



This symbol, on the instrument, indicates do not throw-away in domestic bin, hazardous material, dispose correctly in accordance with local regulations.

## Pressure units and conversion factors

Pressure units	Factor (hPa)	Pressure units	Factor (hPa)
mbar	1.0	cmH <sub>2</sub> O @ 20°C	0.978903642
bar	1000.0	mH <sub>2</sub> O @ 20°C	97.8903642
Pa (N/m <sup>2</sup> )	0.01	kg/m <sup>2</sup>	0.0980665
hPa	1.0	kg/cm <sup>2</sup>	980.665
kPa	10.0	torr	1.333223684
MPa	10000.0	atm	1013.25
mmHg @ 0°C	1.333223874	psi	68.94757293
cmHg @ 0°C	13.33223874	lb/ft <sup>2</sup>	0.4788025898
mHg @ 0°C	1333.223874	inH <sub>2</sub> O @ 4°C	2.4908891
inHg @ 0°C	33.86388640341	inH <sub>2</sub> O @ 20°C	2.486413
mmH <sub>2</sub> O @ 4°C	0.0980665	inH <sub>2</sub> O @ 60°F	2.487641558
cmH <sub>2</sub> O @ 4°C	0.980665	ftH <sub>2</sub> O @ 4°C	29.8906692
mH <sub>2</sub> O @ 4°C	98.0665	ftH <sub>2</sub> O @ 20°C	29.836983
mmH <sub>2</sub> O @ 20°C	0.097890364	ftH <sub>2</sub> O @ 60°F	29.8516987

### Unit Conversion

To convert FROM pressure VALUE 1 in pressure UNITS 1

TO pressure VALUE 2 in pressure UNITS 2, calculate as follows:

$$\text{VALUE 2} = \frac{\text{VALUE 1} \times \text{FACTOR 1}}{\text{FACTOR 2}}$$

#### Note:

The PACE instrument contains selectable pressure units and user defined units. Use the conversion factors to calculate a user defined unit from the table above. Refer to the data sheets SDS0001 or SDS0008 for the list of selectable pressure units.

# CONTENTS

<b>Section</b>	<b>Title</b>	<b>Page</b>
1	Description .....	1-1
1.1	Introduction .....	1-1
2	Installation.....	2-1
2.1	Packaging.....	2-1
2.2	Packaging for Storage and Transportation.....	2-1
2.3	Preparation for Use.....	2-1
2.4	Pneumatic connections .....	2-2
2.5	Rack-mount option .....	2-7
2.6	Electrical connections.....	2-8
3	OPERATION.....	3-1
3.1	Preparation .....	3-1
3.2	Power-up Sequence .....	3-2
3.3	Measure Mode.....	3-3
3.4	Control Mode.....	3-5
3.5	Operation and Example Procedures.....	3-8
3.6	Global Set-up .....	3-12
3.7	Barometric Reference Option.....	3-13
3.8	Supervisor Set-up .....	3-14
3.9	Instrument Status .....	3-15

4	MAINTENANCE.....	4-1
4.1	Introduction.....	4-1
4.2	Visual inspection.....	4-1
4.3	Cleaning.....	4-1
4.4	Test.....	4-1
4.5	Calibration.....	4-1
4.6	Replacement parts.....	4-2
4.7	Fuse replacement.....	4-2
4.8	Filter replacement.....	4-4
4.9	Pressure module replacement.....	4-5
5	TESTING AND FAULT FINDING.....	5-1
5.1	Introduction.....	5-1
5.2	Standard Serviceability Test.....	5-1
5.3	Fault Finding.....	5-2
5.4	Approved Service Agents.....	5-3
6	REFERENCE AND SPECIFICATION.....	6-1
6.1	Installation notes.....	6-1
6.2	Operational Requirements.....	6-4
6.3	Icons.....	6-6
6.4	Measure Set-up.....	6-9
6.5	Control Set-up.....	6-10
6.6	Global Set-up.....	6-11
6.7	Supervisor Set-up.....	6-12
6.8	Options.....	6-15



6.8	Calibration.....	6-28
6.9	Communications - Instrument Emulation.....	6-29
6.10	Specification.....	6-29
6.11	Return Goods/Material Procedure.....	6-29
6.12	Packaging Procedure.....	6-30

intentionally left blank

## 1 Description

### 1.1 Introduction

The PACE5000 single-channel and PACE6000 single/dual-channel, Pressure Automated Calibration Equipment measures and controls pneumatic pressures and displays, on a touch-screen, the pressure measurement and controller status. The touch-screen enables selections and settings in both measure and control modes. The instrument can be operated remotely through communication interfaces.



Figure 1-1 PACE5000 General view



Figure 1-2 PACE6000 General view

The rear of the instrument houses all the electrical and pneumatic output and input connections. The electrical connections provide an a.c. power supply, serial and parallel communication interfaces, d.c. output and logic input and output. The system pneumatic controller module contains a positive and negative pressure supply port, an output port, vent port and reference port.

# 1 Description

The instrument can be mounted in a standard 19 inch rack system (rack-mount option).



Figure 1-3 PACE5000 Rear view

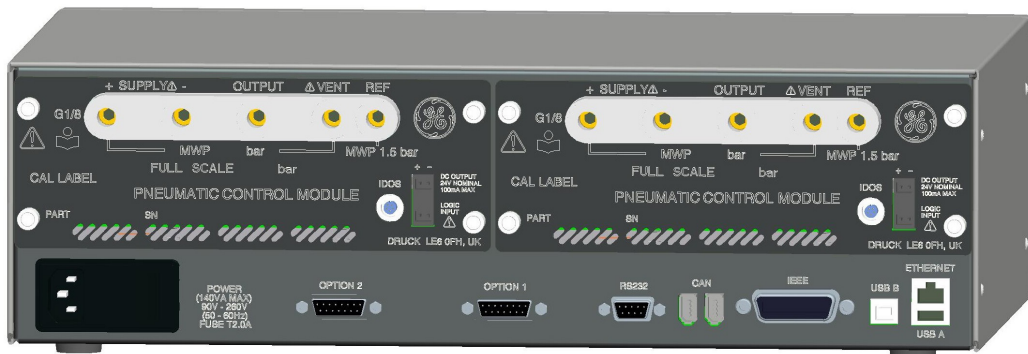

Figure 1-4 PACE6000 Rear view

Options available for the PACE5000 and PACE6000 are detailed in datasheet SDS0001 (PACE5000) and SDS00008 (PACE6000).

Further information and notes on applications are available in section 6 of this manual and on the GE Sensing & Inspection web site at [www.gesensinginspection.com](http://www.gesensinginspection.com).

## 2 Installation

### 2.1 Packaging

On receipt of the PACE5000 or PACE6000 check the contents of the packaging against the following list:

#### **Packaging List**

- i) PACE5000 or PACE6000 Pressure Controller.
- ii) Cable, power supply.
- iii) User guide and CD (UD-0001) containing the full documentation suite.
- iv) Pneumatic Control Module blanking plate (keep this plate for future use).

#### **CAUTIONS:**

1. AFTER REMOVING A CONTROL MODULE, USE A BLANKING PLATE TO KEEP THE FLOW OF COOLING AIR.
2. AFTER UNPACKING AN INSTRUMENT THAT HAS BEEN IN COLD CONDITIONS ALLOW TIME TO STABILISE AND ANY CONDENSATION TO EVAPORATE.

### 2.2 Packaging for Storage or Transportation

To store the instrument or to return the instrument\* for calibration or repair carry out the following procedures:

1. Pack the instrument as detailed in section 6.8, Reference and Specification.
2. Return the instrument for calibration or repair complete the return goods procedure detailed in section 6.8, Reference and Specification.

\* *This procedure also applies to the pressure control module as a separate item.*

### 2.3 Preparation for Use

The instrument can be used as a:

- Free-standing instrument positioned on a horizontal surface.
- Rack-mounted in a standard 19 inch rack using the rack-mount accessory option kit (refer to section 2.5).

For free-standing instruments, use the two front feet on the base to elevate the instrument to provide a better viewing angle.

**Note:** *The cooling air outlet on the underside of the instrument must not be obstructed. Allow a free flow of air around the instrument, especially at high ambient temperatures.*

## 2 Installation

### 2.4 Pneumatic connections

#### WARNINGS:

TURN OFF THE SOURCE PRESSURE AND CAREFULLY VENT THE PRESSURE LINES BEFORE DISCONNECTING OR CONNECTING THE PRESSURE LINES. PROCEED WITH CARE.

ONLY USE EQUIPMENT WITH THE CORRECT PRESSURE RATING.

BEFORE APPLYING PRESSURE, EXAMINE ALL FITTINGS AND EQUIPMENT FOR DAMAGE. REPLACE ALL DAMAGED FITTINGS AND EQUIPMENT. DO NOT USE ANY DAMAGED FITTINGS AND EQUIPMENT.

#### Connection adaptor

Input	supply +	G 1/8
	supply -	G 1/8
Output		G 1/8
	Vent	G 1/8
	Reference	G 1/8

Refer to the data sheets SDS0001 or SDS0008 for a complete range of adaptors.

#### Pressure supply (Figure 2-1)

1. The pressure supply must be clean, dry gas, nitrogen or air and at the correct pressure, refer to the specification (Section 6).
2. Ensure the user systems can be isolated and vented.
3. Connect pressure and vacuum supplies to the SUPPLY + and SUPPLY - connection ports.
4. Connect the Unit Under Test (UUT) to the required outlet connection port.

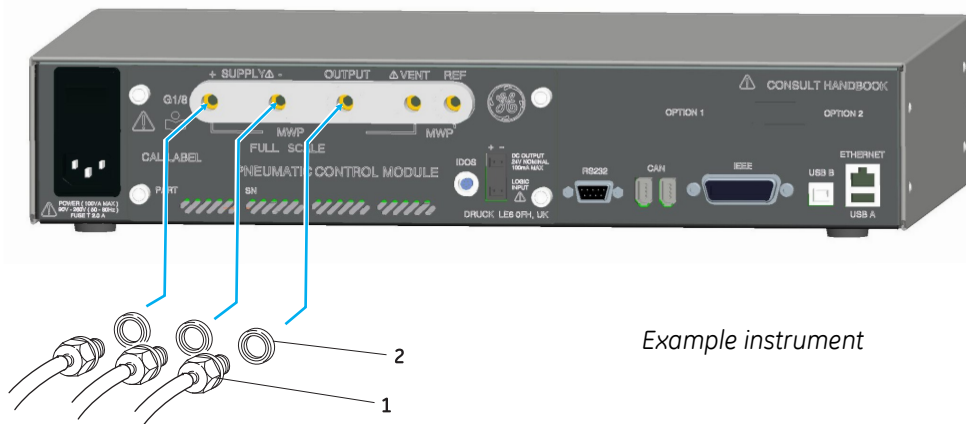

- 1 BSP connector    2 Bonded seal

**Note:** For instruments with NPT connections, use adequate pressure sealing.

**Figure 2-1, Pneumatic Connections**

## Installation

The instrument requires a positive pressure supply, instruments operating in an absolute range or negative pressure range require a vacuum supply. A vacuum supply should be used for a fast response for instruments operating near atmospheric pressure. For dual channel operation two independent pressure and vacuum supplies can be used.

### **Important notes**

*When using two pressure modules, make sure that the modules are compatible, refer to Section 4.9. All connections must comply with the Pressure Equipment Directive (PED).*

*When connecting the output ports of two pressure modules together make sure both are either:*

- *below 70 bar.*

*OR*

- *between 100 to 210 bar.*

*To comply with the Pressure Equipment Directive (PED) do not mix these categories.*

## Supply equipment

Pneumatic supplies should have isolation valves and, where necessary, conditioning equipment. The positive pressure supply should be regulated to between 110% of the full-scale pressure range and MWP stated on the control module.

To protect the control module, for ranges above 100 bar, from over-pressure a suitable protection device (such as a relief valve or bursting disc) must be fitted to limit the applied supply pressure to below the MWP.

On instruments without a negative supply, the positive pressure discharges from the system to atmosphere through the negative supply port. Fit the diffuser to the negative port to diffuse airflow.

During system pressure vent operations, the pressure discharges from the system to atmosphere through the vent port. Fit a diffuser to the vent port to diffuse airflow.

## 2 Installation

### Pneumatic Connection Examples (Figures 2-2 and 2-4)

These examples show a single channel connection detail using supply equipment described above.

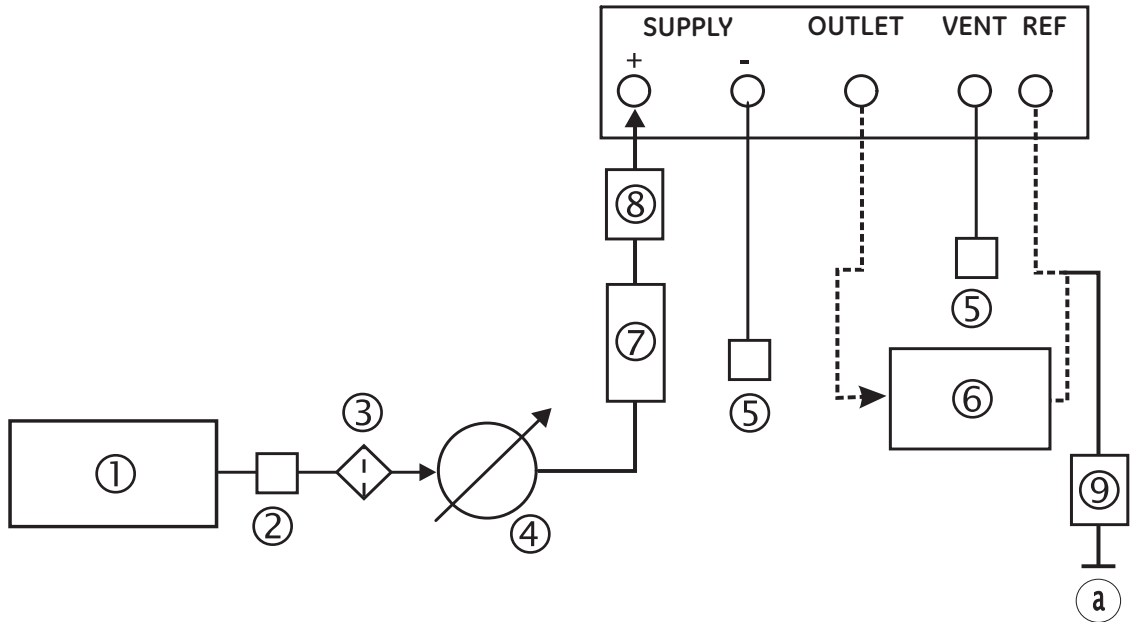

Figure 2-2, Pneumatic Connections without vacuum supply

#### Key to Figure 2-2

1	Pressure source	2	Conditioner	3	Filter
4	Regulate to between 110% full-scale and MWP	6	Unit under test	7	Optional reservoir †
5	Diffuser *	9	Optional differential connection ★	a	atmosphere
8	Protection device ◉				

**Notes:** Refer to Section 6 Reference and Specification for details of other system components.

\* High pressure gas exhaust - depending on pressure range.

† Optimum controller transient response and minimum time to set-point may be degraded if either the pneumatic supply or vacuum system has restricted flow. Installing a reservoir volume, which has larger capacity than the load volume, located in close proximity to the controller supply ports can improve the controller response.

◉ To protect the control module, for ranges above 100 bar, from over-pressure a suitable protection device (such as a relief valve or bursting disc) must be fitted to limit the applied supply pressure to below the MWP.

★ Optional differential connection kit.



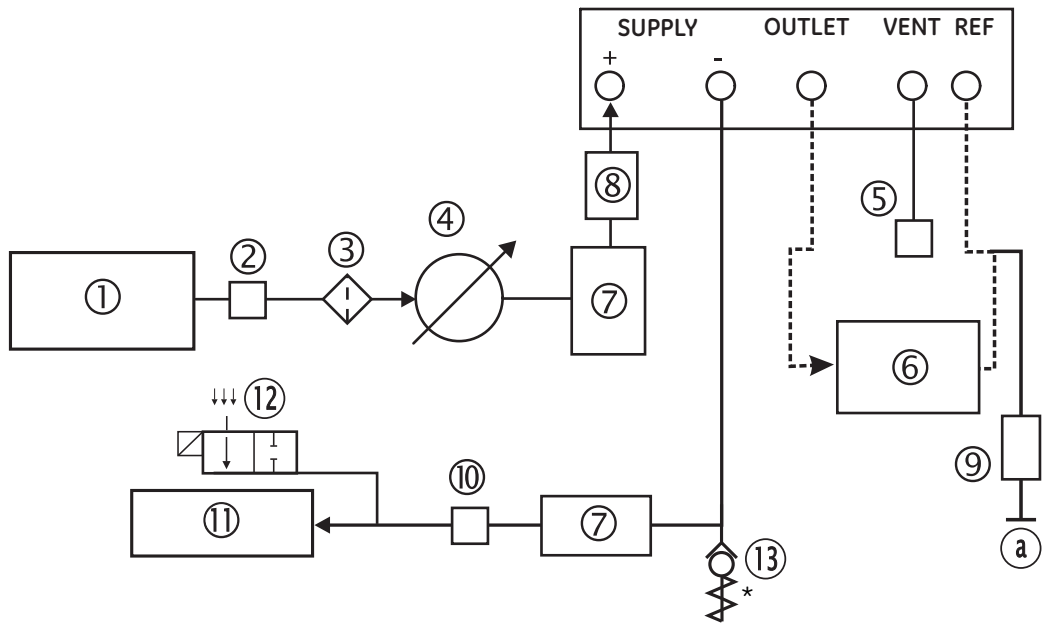

Figure 2-3, Pneumatic Connections with vacuum supply

Key to Figure 2-3

- |    |   |    |                                    |    |  |
|----|---|----|------------------------------------|----|--|
| 1  | Pressure source                             | 2  | Conditioner                        | 3  | Filter                                 |
| 4  | Regulate to between 110% full-scale and MWP |    |                                    |    |  |
| 5  | Diffuser*                                   | 6  | Unit under test                    | 7  | Optional reservoir †                   |
| 8  | Protection device ⊙                         | 9  | Optional differential connection ★ |    |  |
| 10 | Oil mist trap                               | 11 | Vacuum source                      | 12 | Normally open electrical release valve |
| 13 | Check valve ‡                               | a  | atmosphere                         |    |  |

**Notes:** Refer to Section 6 Reference and Specification for details of other system components.

\* High pressure gas exhaust - depending on pressure range.

† Optimum controller transient response and minimum time to set-point may be degraded if either the pneumatic supply or vacuum system has restricted flow. Installing a reservoir volume, which has larger capacity than the load volume, located in close proximity to the controller supply ports can improve the controller response.

‡ Optional vacuum system kit.

⊙ To protect the control module, for ranges above 100 bar, from over-pressure a suitable protection device (such as a relief valve or bursting disc) must be fitted to limit the applied supply pressure to below the MWP.

★ Optional differential connection kit.

## 2 Installation

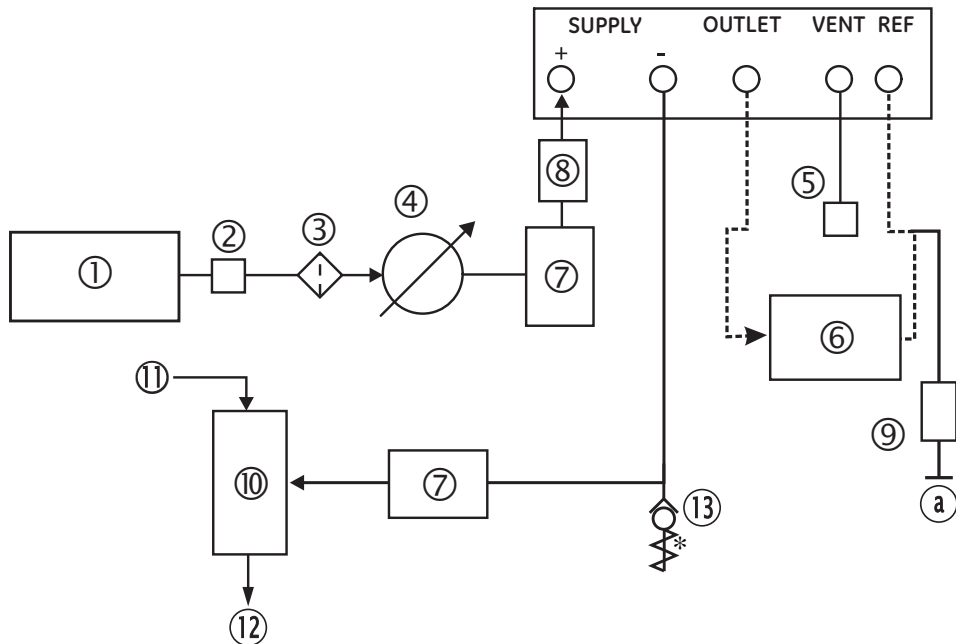

Figure 2-4, Pneumatic Connections with negative gauge pressure generator

### Key to Figure 2-4

1	Pressure source	2	Conditioner	3	Filter
4	Regulate to between 110% full-scale and MWP				
5	Diffuser *	6	Unit under test	7	Optional reservoir †
8	Protection device ⊙	9	Optional differential connection ★	a	atmosphere
10	Vacuum generator ‡	11	Source pressure (regulated compressed air supply)		
12	Exhaust to atmosphere	13	Check valve ‡		

**Notes:** Refer to Section 6 Reference and Specification for details of other system components.

\* High pressure gas exhaust - depending on pressure range.

† Optimum controller transient response and minimum time to set-point may be degraded if either the pneumatic supply or vacuum system has restricted flow. Installing a reservoir volume, which has larger capacity than the load volume, located in close proximity to the controller supply ports can improve the controller response.

‡ Optional negative gauge generator kit.

⊙ To protect the control module, for ranges above 100 bar, from over-pressure a suitable protection device (such as a relief valve or bursting disc) must be fitted to limit the applied supply pressure to below the MWP.

★ Optional differential connection kit.

## 2.5 Rack-mount option (Figure 2-5)

### General

There must be enough space at the rear of the instrument for all the cables and pipes. The length of the cables and pipes must allow for the removal and fitment of the instrument. The cooling air of the instrument must not be obstructed. Allow a free flow of air through the equipment rack and around the instrument, especially at high ambient temperatures.

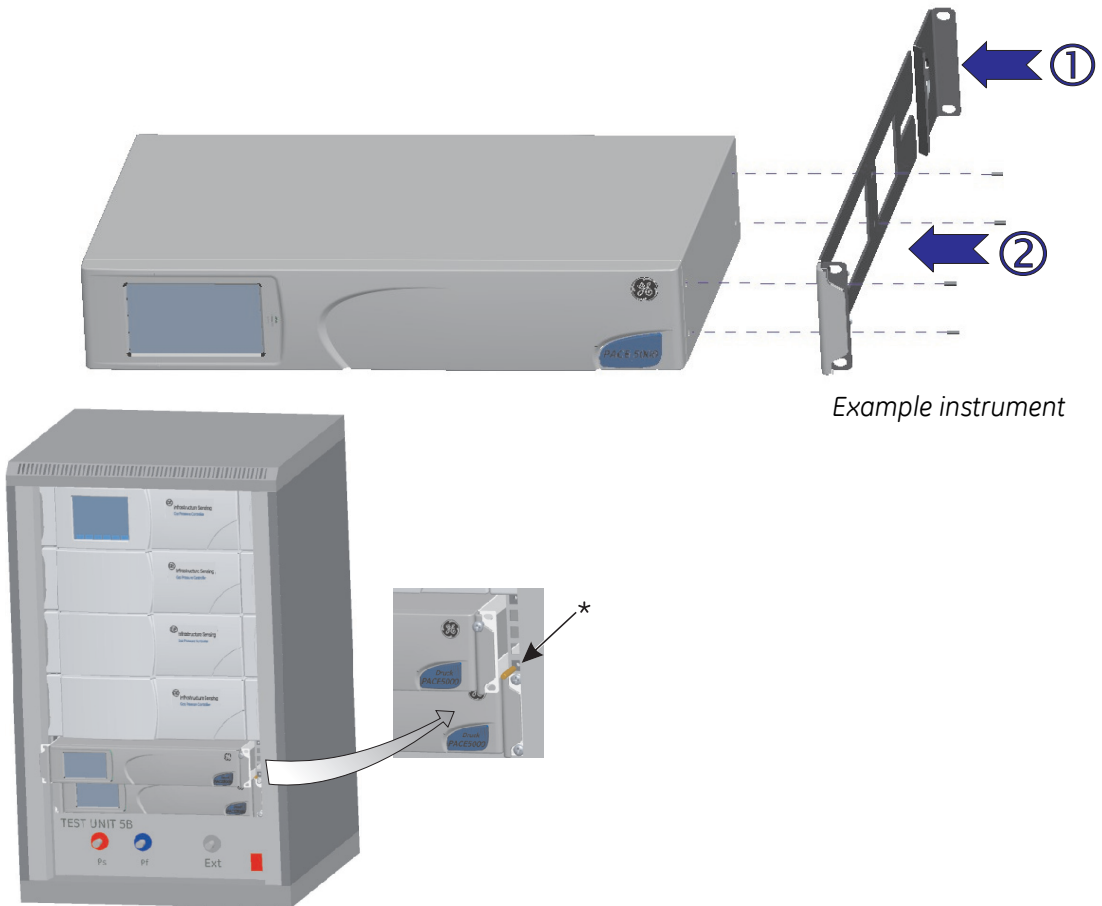

**Figure 2-5 Rack-mounting**

### Procedure

- Locate and secure the back brackets ① to the rear of the equipment rack.
- Unscrew and remove the four countersunk screws from each of the instrument side panels.
- Locate the two brackets ② on each side of the instrument and secure with the four countersunk screws.
- Support the instrument and connect the cables and pipes.

## 2 Installation

---

- Refer to the electrical connections below before finally fitting the instrument into the equipment rack.
- Temporarily locate and screw in the two spigots\* to each side of the equipment rack.
- Locate and slide the instrument into the rack, locating the instrument on the spigots\*.
- Secure the instrument in the equipment rack with two of the screws and washers (supplied).
- Remove the two spigots\* and replace with the remaining two screws and washers (supplied).

### 2.6 Electrical connections

#### WARNINGS

1. **THE GROUND LEAD OF THE INSTRUMENT MUST BE CONNECTED TO THE AC SUPPLY PROTECTIVE SAFETY GROUND.**
  
2. **ISOLATE THE POWER SUPPLY BEFORE MAKING ANY ELECTRICAL CONNECTIONS TO THE REAR PANEL.**

#### General

The instrument must be connected to the correct electrical power supply as stated on a label next to the power connector. Also see section 6 Reference and Specification.

Make sure that the power supply is off before connecting the power cable.

#### Requirements for rack-mounted instruments

- Install an isolator in the power supply circuit. The power supply connector and switch on the rear panel of the instrument will not be accessible.
- Set the power supply isolator to OFF. Connect the power supply and set the power supply switch to ON before sliding the instrument into the rack.
- Set the power supply isolator to ON .

Check that the front panel display shows the power-up sequence.

#### Connecting (Figure 2-6)

To connect the power supply to the instrument proceed as follows:

- Insert the IEC power connector (1) into the power supply connector at the rear of the instrument.
- Set the ON/OFF switch to ON.
- Check that the front panel display shows the power-up sequence.

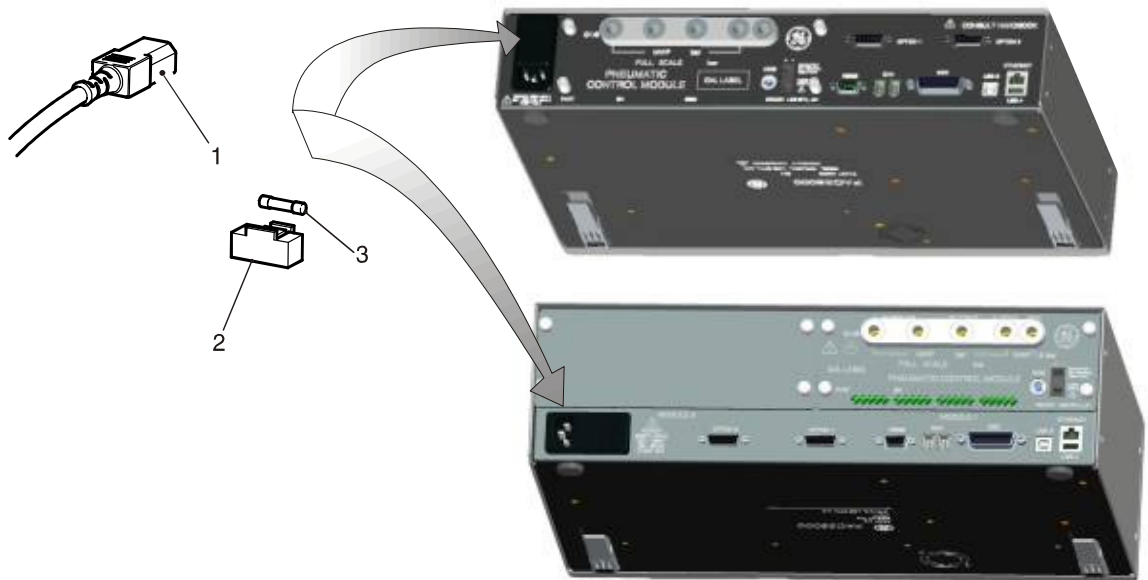

1 IEC power connector    2 Fuse carrier    3 Fuse

**Figure 2-6 Electrical Connections**

## Pressure Control Module Input and Output Connectors

### 24V DC Output @ 100mA maximum

Using a 4-way connector:    pin "+"    =    +24 Vdc  
  pin "-"    =    0 Vdc

This facility can energise external equipment. An integral self-resetting fuse protects this output.

### Logic (switch) Input

Using a 4-way connector:    Input  
  Output

This facility can be used to trigger the instrument from a pressure switch contact during the Pressure Switch Task (see Section 3.4). Connections are not polarised and can be connected either way. Integral opto-isolators protect this input circuit.

## 2 Installation

### Communication Connections

Connect the appropriate connectors into the rear panel communications ports and, if appropriate, secure with the captive screws.

**Note:** The RS232 and IEEE 488 interfaces are both enabled at power-up. Set the required parameters in Supervisor Setup/communications menu, see Section 3.8.

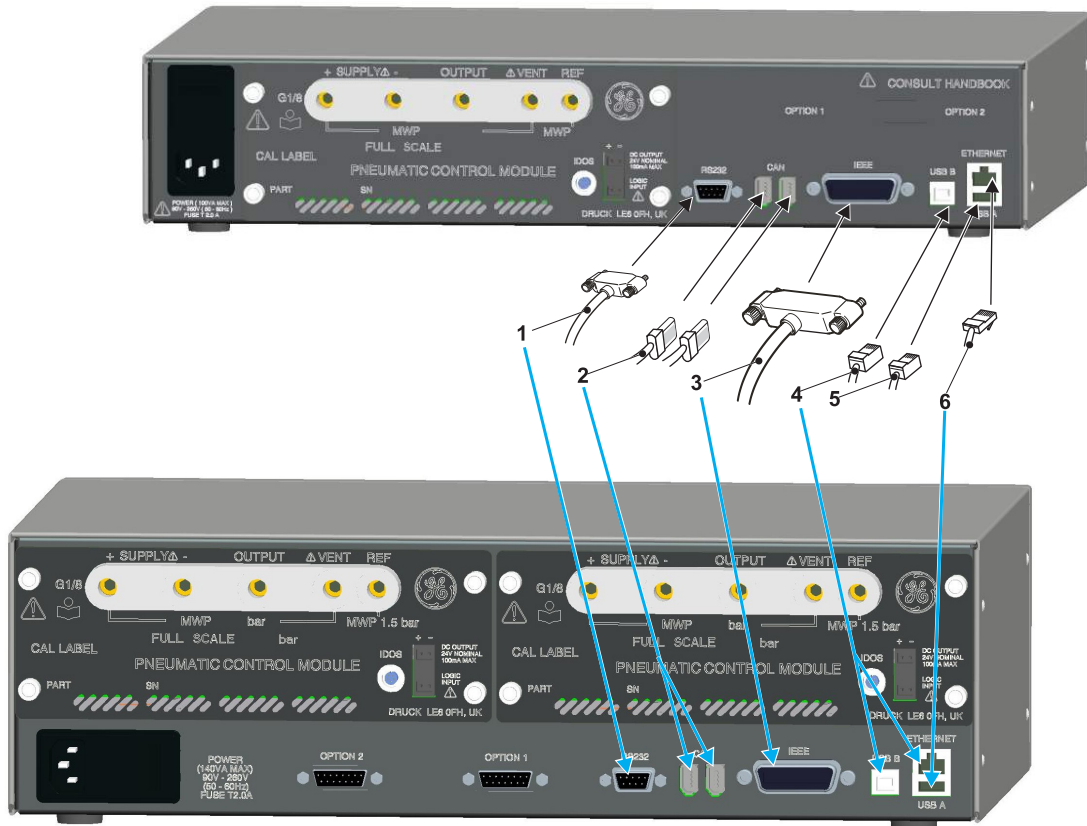

**Figure 2-7, Communication Connectors**

1	RS232	2	Canbus (option)	3	IEEE488	4	USB B
5	USB A	6	Ethernet (option)				

### RS232 Interface

When using the RS232 interface, a cable must be connected directly from the instrument to a suitable port on the computer in a 'point to point' link. The pin connections for the 9-pin D-type, RS232 connector and the relationship between the instrument and the RS232 control signals, together with device interconnection interface is shown in Table 2-1. The instrument is configured as Data Circuit Terminating Equipment (DCE).

Instrument		Control Line		Computer/Printer	
Instrument Function	Connector 9-way D-type Pin No.	Signal Direction	RS232 Terminology	Connector Type	
				9-way D-type Pin No.	25-way D-type Pin No.
RxD (I/P)	3	←	TxD	3	2
TxD (O/P)	2	→	RxD	2	3
GND	5	↔	GND	5	7
CTS (I/P)	7	←	RTS	7	4
RTS (O/P)	8	→	CTS	8	5
Pulled high internally	1	→	RLSD (DCD)	1	8
Not connected	4	←	DTR	4	20
Pulled high internally	6	↔	DSR DCE Ready	6	6
Equipment chassis	Connector shell	↔	Cable Screen	-	1

Table 2-1, RS232 Connections

### Handshaking connections

Software handshaking use: TXD, RXD and GND.

Hardware handshaking use: TXD, RXD, GND, CTS, RTS and DTR.

## 2 Installation

---

### IEEE 488 Interface

This interface complies with IEEE 488 standard. The IEEE 488 parallel interface connects a computer/controller to one or more PACE instrument and possibly other instruments. Up to 30 instruments can be connected through a high-speed data bus to the computer/controller.

**Note:** *The length of each IEEE 488 cable must be less than 3 metres to comply with the EMC requirements, see Section 6 Reference and Specification.*

### Single Unit Installation (Figure 2-8)

Connect an IEEE 488 connector/cable assembly to the rear panel IEEE 488 connector of the instrument.

- Connect the other end of the connector/cable assembly to the IEEE 488 connector on the controller/computer.
- Change the IEEE 488 communication parameters as described in the Supervisor set-up (refer to Section 6.7).

### Multiple Unit Installation (Figure 2-8)

To install multiple units use stacking plugs to link from first instrument to the second instrument. Proceed as follows.

- Connect a pair of IEEE 488 stacking connectors to the rear panel IEEE 488 connector of the instrument

- 1 Connector to rear panel of first instrument.
- 2 Connector from controller/computer.
- 3 Connector to rear panel of second instrument.

- Connect the other end of one of the connectors to the IEEE 488 connector on the controller/computer and the other connector into the next instrument
- Repeat this procedure for all the instruments in the system.
- Use the Supervisor set-up (communications) menu on each instrument to set-up the required communication parameters (refer to Section 3.8).

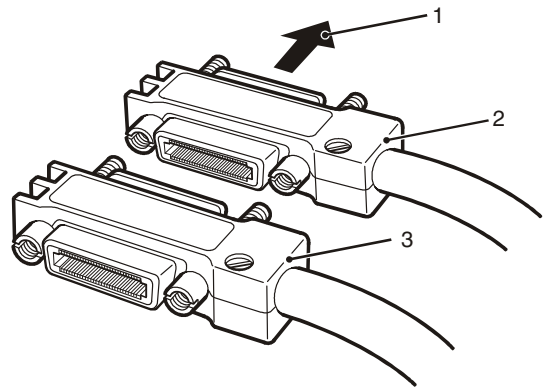



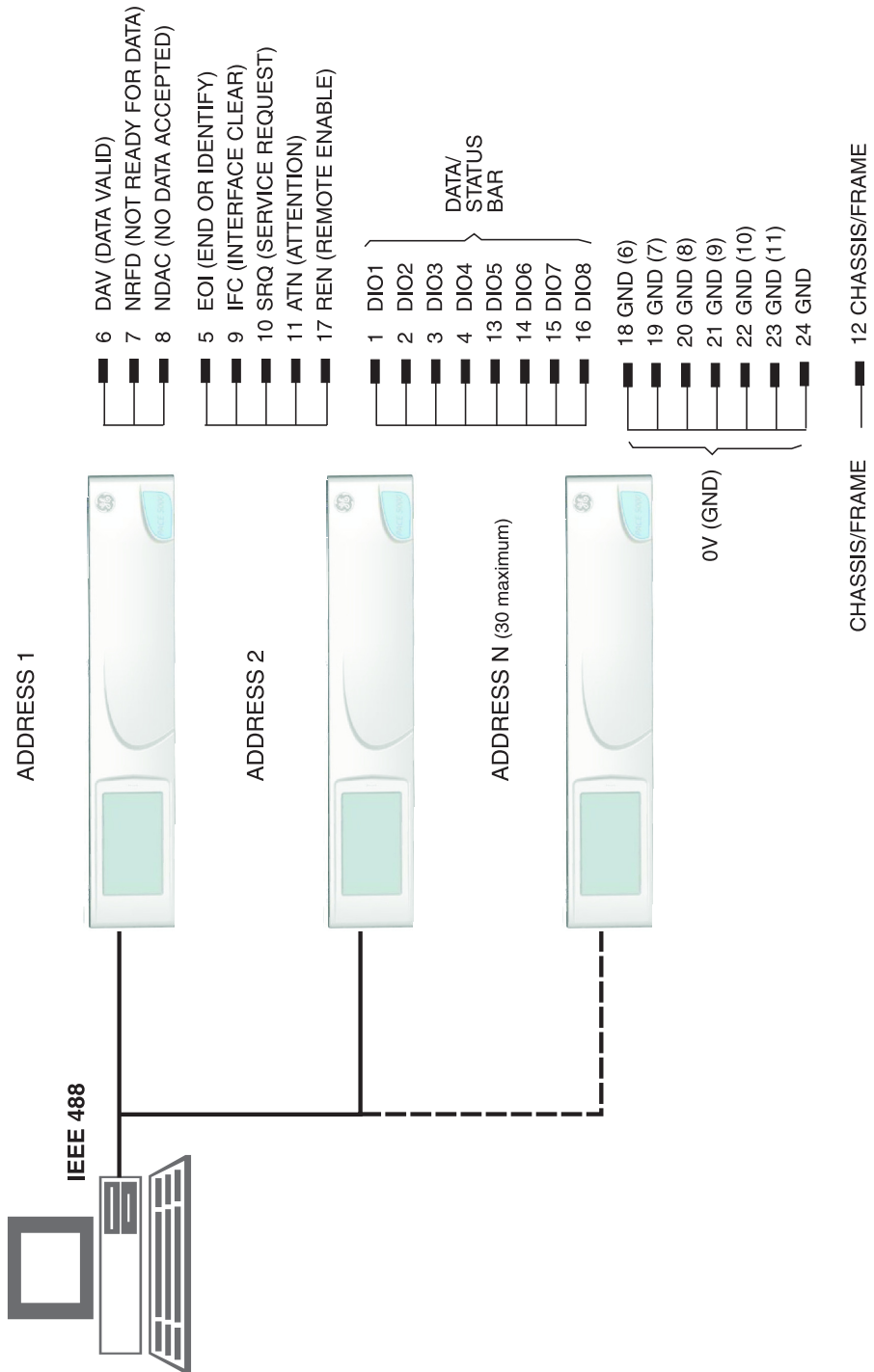

Figure 2-8 - IEEE 488 Connection

intentionally left blank

## 3 Operation

### 3.1 Preparation

Make sure the electrical cables and pneumatic pipes comply with the installation requirements in Section 2.

Carry out the following before use:

- If necessary, carry out the maintenance task detailed in Section 4.
  
- For bench-top, single instrument operation carry out the following:
  1. Make sure the instrument power supply switch on the rear panel is set to OFF.
  2. Connect the instrument to the electrical supply, make sure the supply includes a connection to a protective earth.
  3. Inspect the pneumatic hoses for damage, ingress of dirt and moisture.

Before use, the instrument should be tested.

This section contains quick reference charts detailing all the available functions. The functions shown and described may not be available on some models.

Review and become familiar with the whole procedure before starting a process on a component or system.

### 3 Operation

#### 3.2 Power-up sequence

The following sequences of operation show the instrument in measure or control mode.

**Note:** The following sequence is an example, the values and selections displayed depend on the range(s) and options enabled in the instrument. To control pressure, the outlet port must be connected to a UUT or a blanking plug fitted. The UUT must be of the correct pressure rating or the instrument set to limit the set-point value to a safe pressure.

Set the power supply to ON and the power-up routine starts:

- (1) The display screen first shows:
- (2) After a short time the display shows the start of the power-up sequence, the instrument carries out a self-test. If the test finds a fault, the display shows an error, refer to Section 5, Fault Finding and Testing.
- (3) After a successful self-test sequence the system enables the touch screen and changes to measure mode. The touch screen shows the measured pressure in the parameters selected in measure set-up.

**Note:** The PACE 6000 shows a single display (default) this is the left hand pressure control module. Change to dual display in **Global Set-up/Display**.

example display

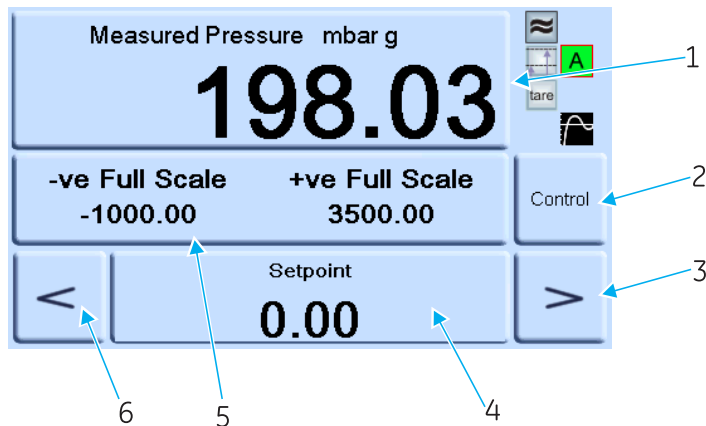
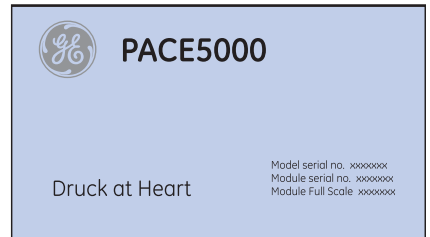

- |   |  |   |                 |   |          |   |                 |
|---|--|---|-----------------|---|----------|---|-----------------|
| 1 | Measure set-up                         | 2 | Control/Measure | 3 | Nudge up | 4 | Set-point entry |
| 5 | Status (touch to enter control set-up) | 6 | Nudge down      |   |          |   |                 |

#### Touch screen areas

- (4) The instrument is now ready for use.

## 3.3 Measure mode

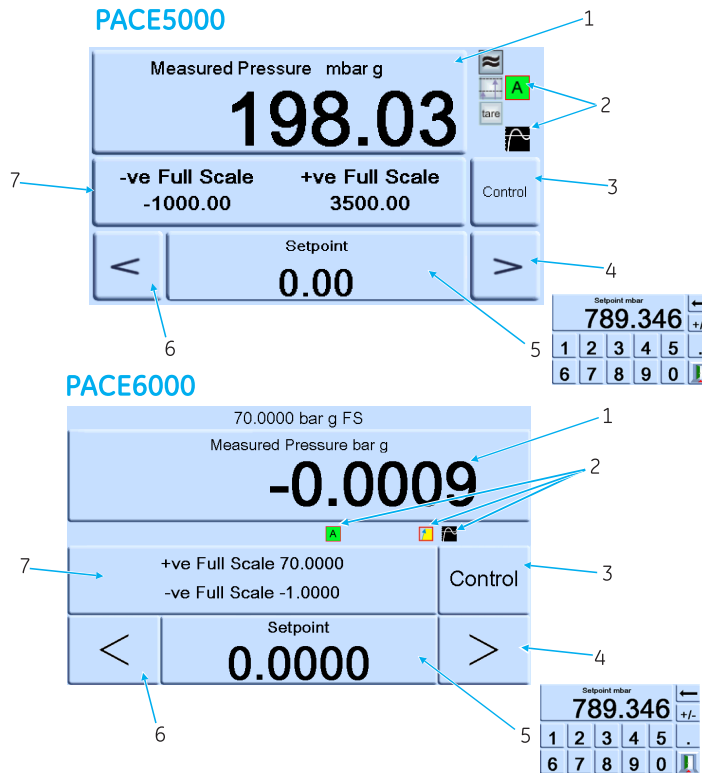

- 1 Pressure measurement of current selected sensor in current selected pressure measurement units
- 2 Current enabled functions
- 3 Control/measure selection
- 4 Nudge up, changed in control set-up
- 5 Current set-point value, change with numeric keys
- 6 Nudge down, changed in control set-up
- 7 Status area, changed in global set-up

### Display Icons

	Auto zero		Control mode with overshoot		Percentage
	Reference level difference (gas head correction)		Control mode with no overshoot		Timed zero
	Control mode active		Filter pressure reading		Tare enabled
	Control mode passive		Linear rate		Zero
	Control mode gauge		Maximum rate		

# 3 Operation

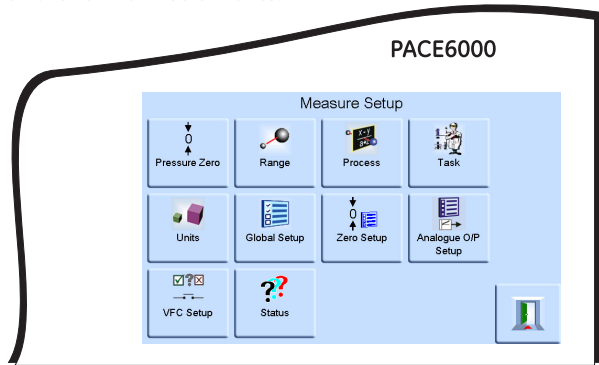
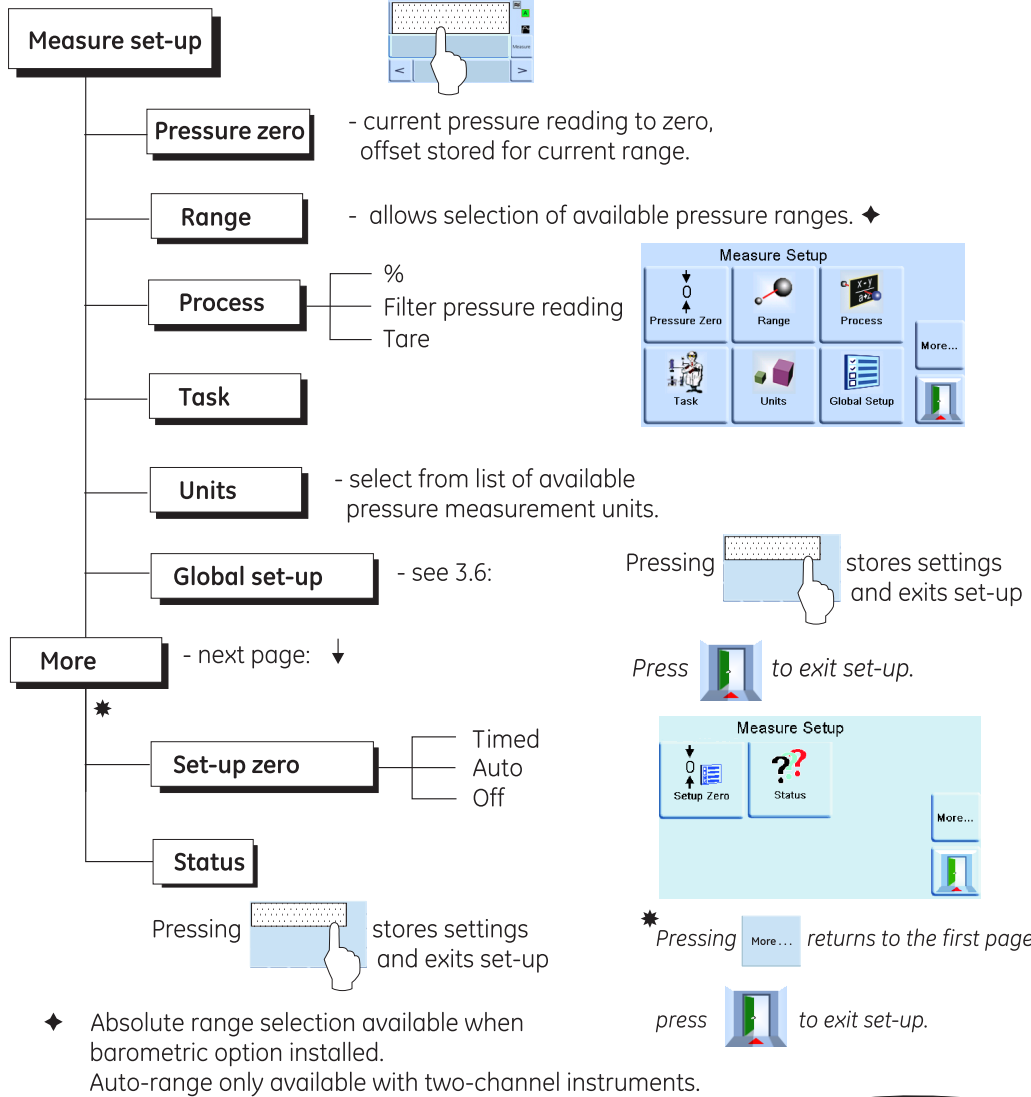

## AUTO-RANGE (only available with two-channel instruments)

### Controller Off – Increasing Set-point

With both controllers in Measure mode, if a set-point within the range of the lower ranged controller is entered and Control is then selected the lower ranged controller controls to the entered set-point.

With both controllers in Measure mode, if a set-point above the range of the lower ranged controller is entered and Control is then selected, then the range is changed to the higher ranged controller and this then controls to the entered set-point.

### Controller Off – Decreasing Set-point

With both controllers in Measure mode, if a set-point within the range of the higher ranged controller is entered and Control is then selected the higher ranged controller controls to the entered set-point.

With both controllers in Measure mode, if a set-point above the range of the lower ranged controller is entered and Control is then selected, then the higher ranged controller will control to this set-point. When the controller is in limits then the range is changed to the lower ranged controller and this then controls to the entered set-point.

### Controller On – Increasing Set-point

With the lower ranged controller in Control mode, if a set-point within the range of the lower ranged controller is entered then the lower ranged controller controls to the entered set-point. If the set-point is increased to above the lower range but still within the higher range then the lower range controller switches off and that the higher range controller switches on and controls to the entered set-point.

### Controller On – Decreasing Set-point

With the higher ranged controller in Control mode, if a set-point within the range of the higher ranged controller is entered then the higher ranged controller controls to the entered set-point.

If the set-point is decreased to within the lower range then the higher range controller will control to this set-point. When the controller is in limits then the range is changed to the lower ranged controller and this then controls to the entered set-point.

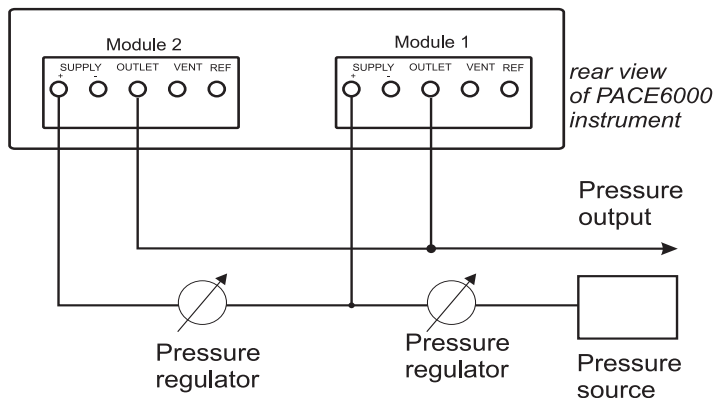

## 3 Operation

### 3.4 Control Mode

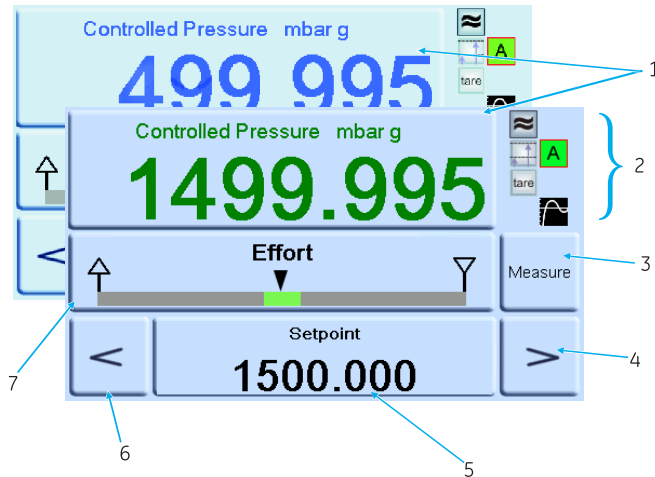

In measure mode, press **Control** and the instrument changes to control mode. Press **Measure** and the instrument stops controlling pressure and changes to measure mode:



#### Key to display

- 1 Current measured pressure value (in limits green, out of limits blue).
- 2 In active control mode.  
Pressure reading filter ON.  
Head (pressure) value applied.  
Control mode with overshoot.  
Tare enabled.
- 3 Press to switch between controlled pressure and measured pressure.
- 4 Nudge up.
- 5 Set-point, press and the display changes to numeric keys.
- 6 Nudge down.
- 7 Status area shows effort meter set in global set-up, press to enter control set-up.

#### Notes:



	Active mode - control active, except in measure mode.
	Passive mode - when the controller achieves inlimits condition, measure mode is automatically selected.
	Gauge mode - when the controller achieves zero gauge inlimits condition, measure mode is automatically selected and the zero valve opens.

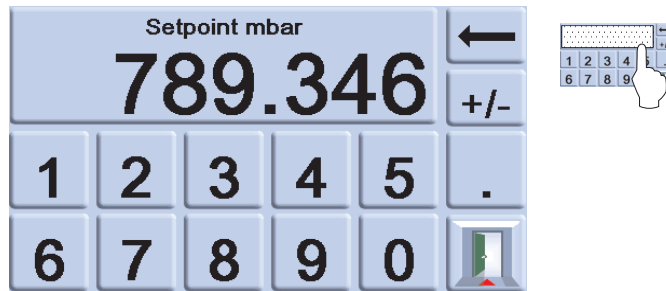

## Controlling to a new set-point

- To change the set-point value, touch the set-point area of the screen and the display shows the numeric keys. Set the new set-point value.





- If necessary, use the  key to remove the last digit in the set-point value display. To save the new set-point, touch the set-point area of the screen. This returns the display to the measured pressure screen and showing the new set-point. Touch the escape  to leave the numeric setting unchanged.
- To control pressure to the new set-point value press the  key. The display shows the pressure value changing as the instrument controls to the new set-point, at the set rate of change.  
*When changing from measured to controlled mode the displayed pressure digits change from black (measured pressure) to blue (controlled pressure out of limits) to green (controlled pressure in-limits).*
- If enabled, the effort meter shows the effort the controller exerts to achieve the set-point. The status area can be changed to various displays showing pressure and controller performance.



Effort meter

**Note:** In normal controlled pressure conditions the effort meter stays within the band (green). If the status indicator moves outside the band there may be a leak into or out of the system.

## Controlling to ambient/zero pressure

- Use the numeric key display and set the new set-point value to ambient or zero gauge pressure.
- When the display shows the new set-point value, press the  key.
- The display shows the pressure value changing as the instrument controls to the new set-point, at the set rate of change.
- When the display shows ambient or zero pressure, press the  key to switch off the controller and return to measure mode.

# 3 Operation

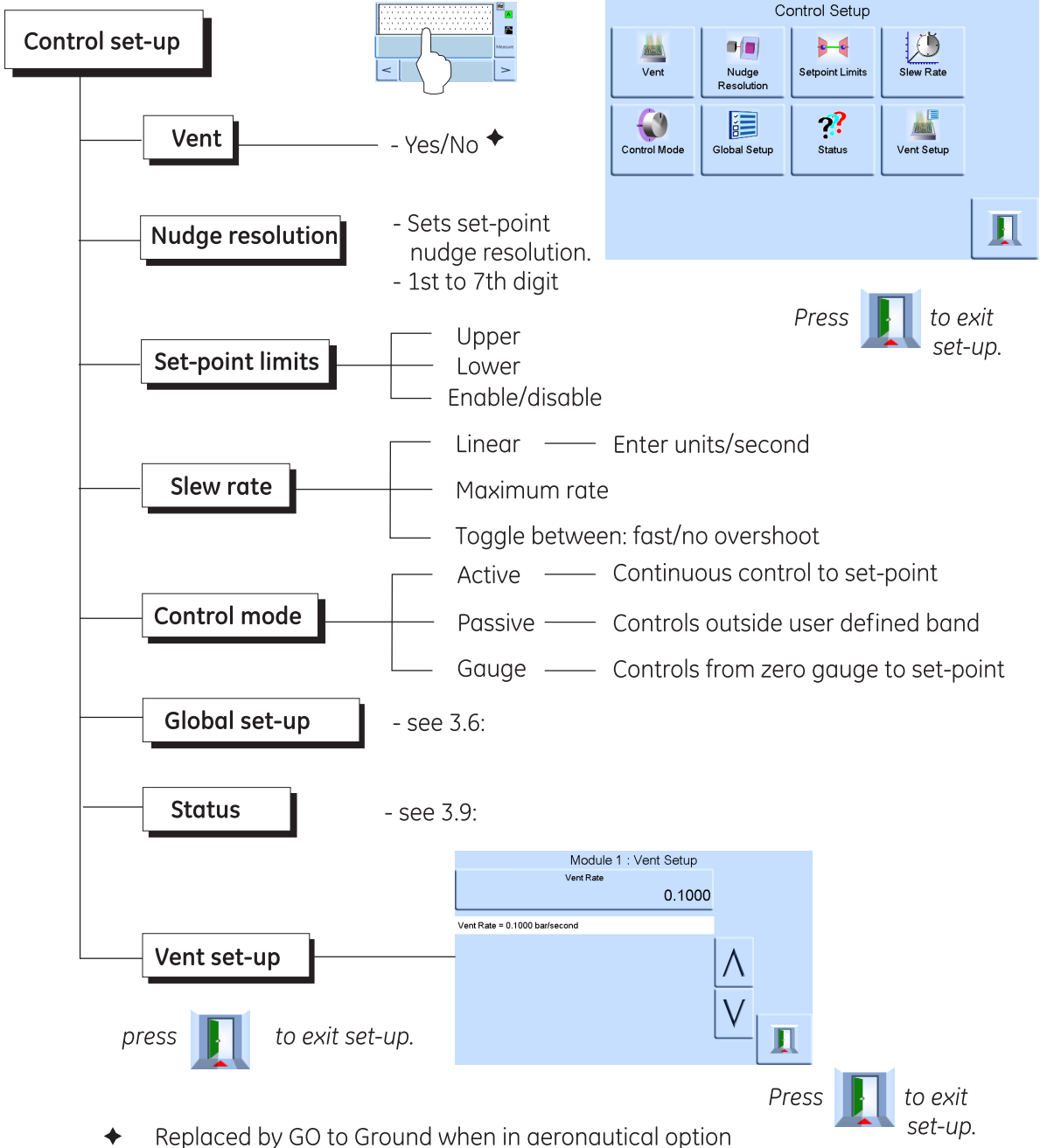

♦ Replaced by GO to Ground when in aeronautical option

## 3.5 Operation and Example Procedures

### Introduction

- Before operation, the instrument must be connected to the correct electrical and pneumatic supplies as detailed in Section 2, Installation.
- Switch the instrument ON and, after a short time, the display shows measured pressure mode (except when regulator mode is selected) and to the task set before the power-off.

### Measure and Control Modes

The instrument operates in two modes, Measure or Control. In Measure mode, the instrument works as a precision pressure indicator and shows the pressure measured at the output port. In Control mode, the instrument works as a precision pressure controller and shows the controlled pressure measured at the output port. Pressing Task enables various pre-determined functions:

### Task

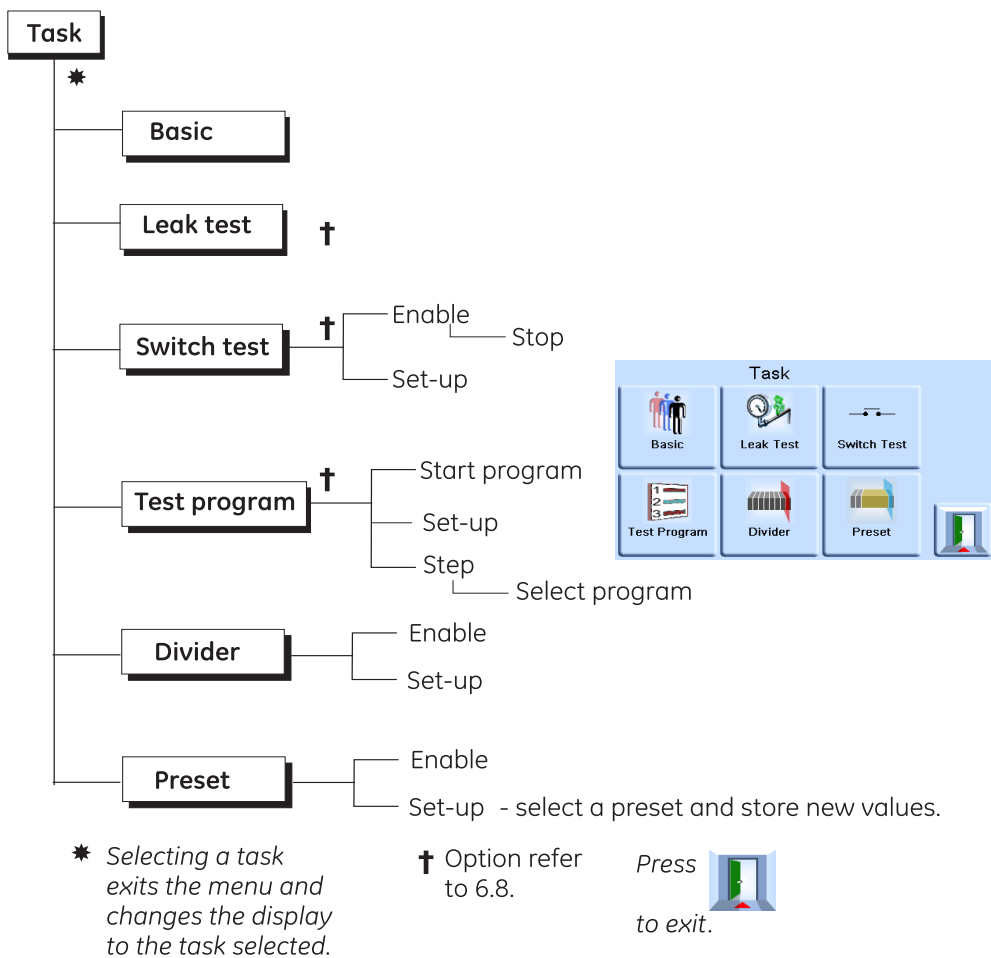

The display shows the task screen. When selected, e.g. Basic, the screen changes to show the selected task.

## 3 Operation

---

### Task

To control pressure in the task proceed as follows:

- (a) Select the required units of pressure measurement from the measure set-up menu.
- (b) Press the status area and enter control set-up, select the required slew rate. The display changes to show the type of slew rate selected. Select the required vent slew rate in vent set-up.

**Caution:** Use the vent set-up to prevent damage to rate-sensitive equipment connected to this controller. The vent slew rate setting is independent of the controller slew rate settings.

Return to the task screen. In basic task, use the numeric keys to enter a set-point.

- (c) Press the **Control** key to start controlling pressure.
- (d) The screen display changes as follows:
  - The current pressure reading changes from black to blue.
  - If enabled, the effort meter indicates the amount of work done (effort) by the controller.
- (e) When the controller achieves the selected pressure set-point, the screen display changes as follows:
  - The current pressure reading changes from blue to green.
  - If enabled, the effort meter shows the controller effort to keep the pressure at the set-point.
- (f) On completion of testing, select control set-up and select **Vent** to reduce the system pressure to near atmospheric pressure. This feature should be used to reduce system pressure to a safe value before disconnecting the Unit Under Test.

**Notes:**

1. *The vent valve opens and remains open until a key press or receipt of a communications command.*
  2. *Always use the vent function before disconnecting pressure equipment from the outlet port.*
- (g) Press the **Measure** key to return to measure mode. The screen display changes as follows:
    - The current pressure reading changes from blue/green to black.
    - If enabled, the effort meter indicates the controller at rest.

## Divider

Select and set-up the divider task by pressing **Divider** from the task screen. The divider menu defines high set-point, low set-point and then divides the span into a number of equal test points (min 2, max 25).

### Divider menu structure

Select required units, Rate, etc. in the set-up menus. When Divider is then entered from the Task menu, these test point pressures and number of test points can be set. By entering control mode, enables the Divider sequence of test pressures (and controlled at the selected rate).

#### Example:

High set-point = 2 bar  
 Low set-point = 0 bar  
 Number of points = 5  
 Test pressures =  
 0, 0.5, 1, 1.5 and 2 bar

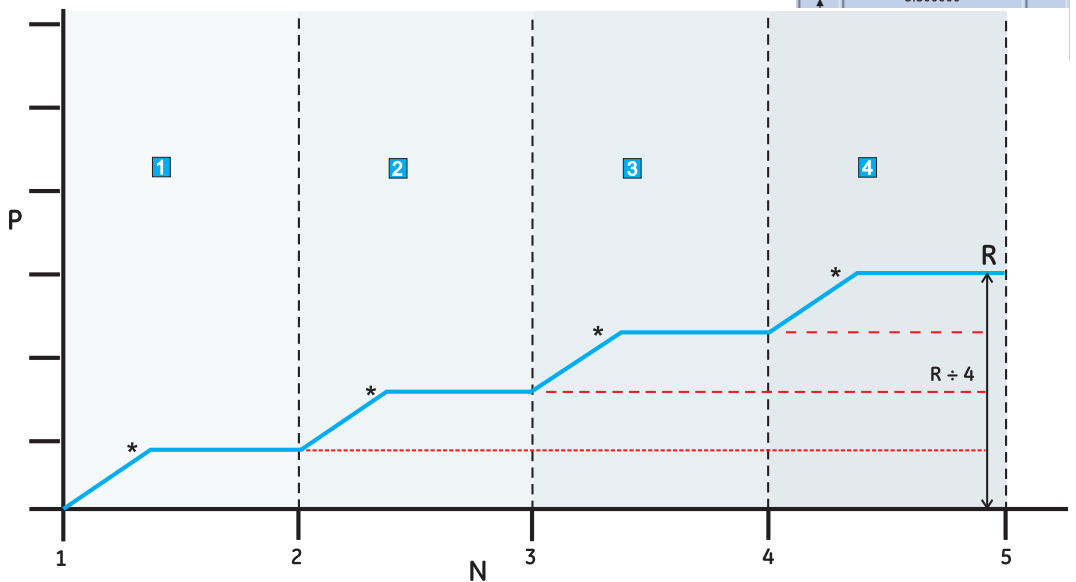
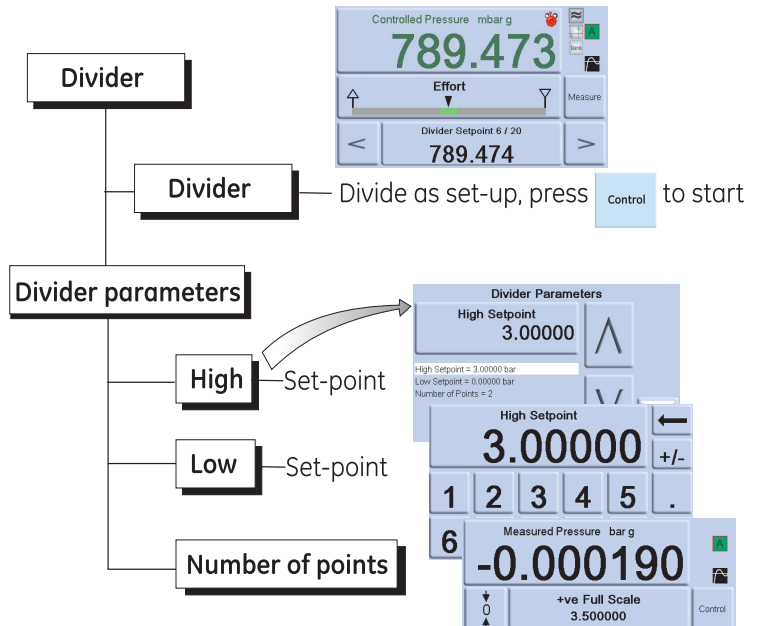

P = pressure  
 N = Number of points  
 R = range between low set-point (1) and high set-point (5)  
 \* controlled pressure to each set-point

### 3 Operation

#### Preset

The **Preset** function is similar to the **Divider** function except that, using this menu, individual set-point values can be defined for each of 25 set-points.

The set-up function displays a preset number, pressing the soft key for that number assigns a pressure value to the key. After setting all the 25 preset pressures, enter control mode and then press a soft key to change to the pressure assigned to that key (and \*controlled at the selected rate).

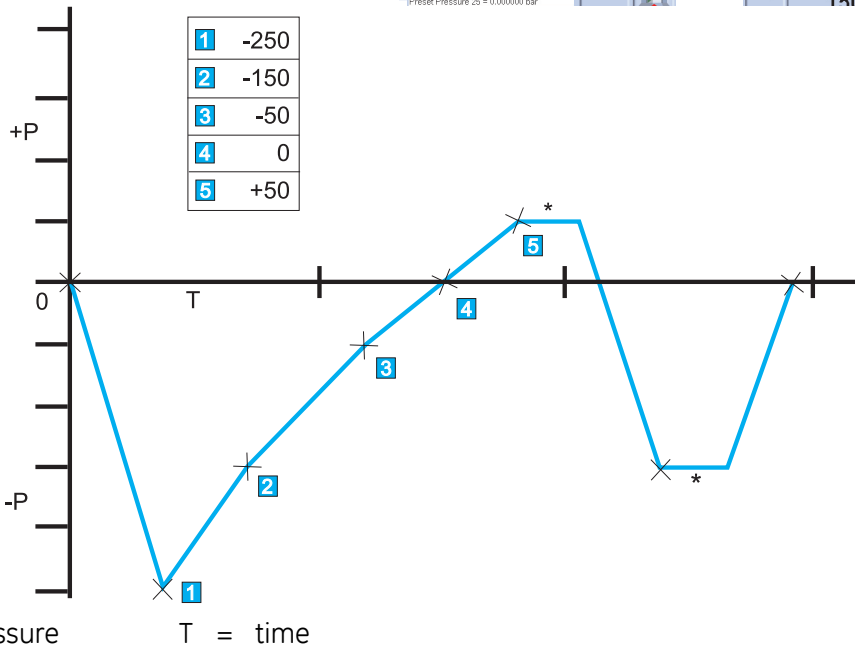
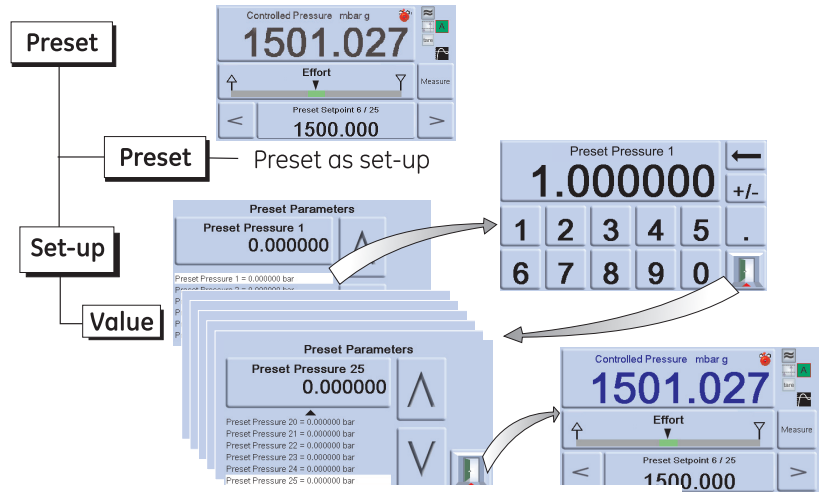

## 3.6 Global Set-up Selections

Global set-up selections provide access to the instrument's settings for both measure and control modes. This set-up menu provides PIN-protected access to the supervisor set-up and calibration.

Pressing Global Set-up from measure or control set-up menu changes the touch-screen display to show five selections, **Supervisor Set-up, Calibration, Save/Recall User Set-up and Display.**

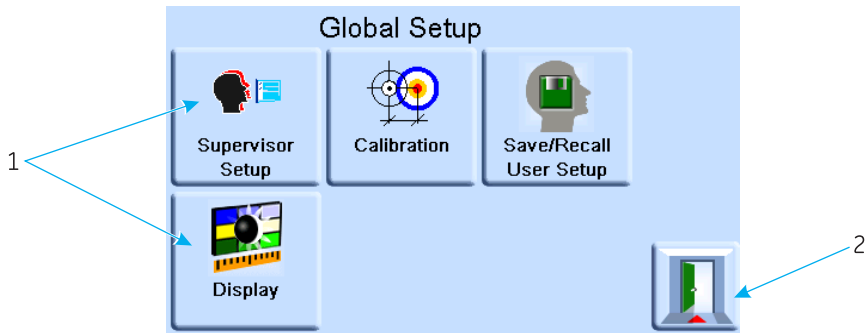

1 Selections      2 Escape key

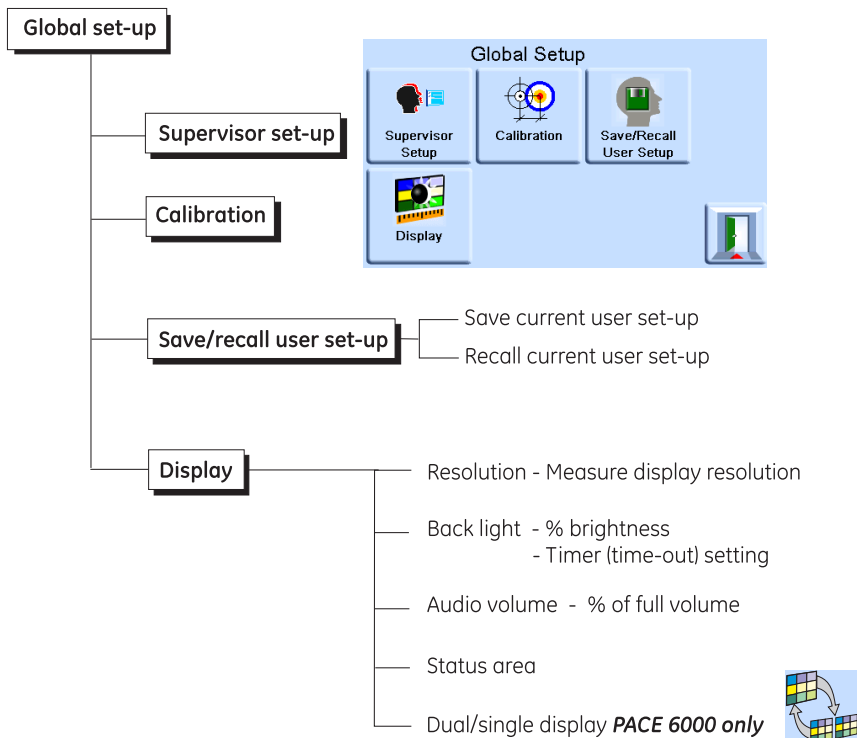

## Status area settings

Enables the user to view an operating condition or parameter of the instrument:

- Full-scale - pressure in current selected units of the pressure range.
- Source - positive and negative source pressure values in current selected units.
- Effort meter - indicates controller effort.
- In Limits meter- indicates controller in-limits condition and time to in-limits.
- Module logic I/P-indicates status condition of logic input of control module.
- Vent and +ve FS-enables vent selection and shows full-scale pressure in current selected units.
- Zero and +ve FS-enables zero selection and shows full-scale pressure in current selected units.
- Rate - indicates slew rate set.
- Barometric - displays barometric pressure.
- Tare - indicates tare condition and value.

Status area examples

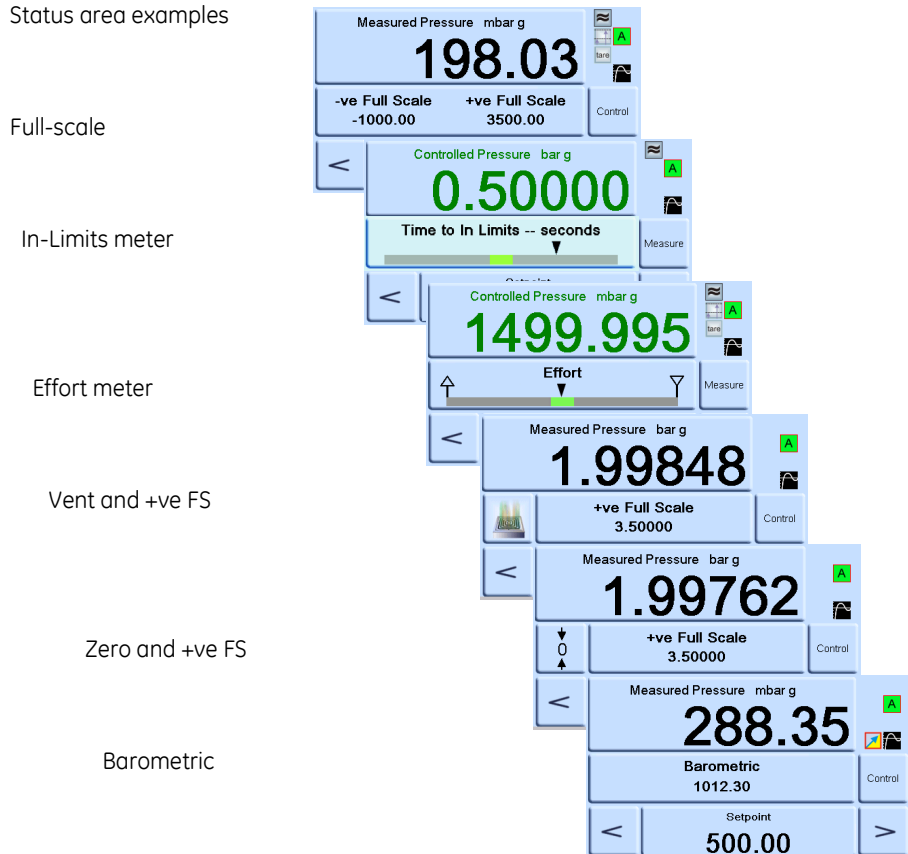

### 3.7 Barometric Reference Option

When installed, this option allows absolute or gauge pressure range selection. To obtain absolute pressure the instrument uses a summation of gauge pressure and barometric pressure (measured by the barometric sensor). Refer to Section 6.8 and the data sheets for the performance of barometric reference and precision of absolute ranges.



## 3.8 Supervisor set-up

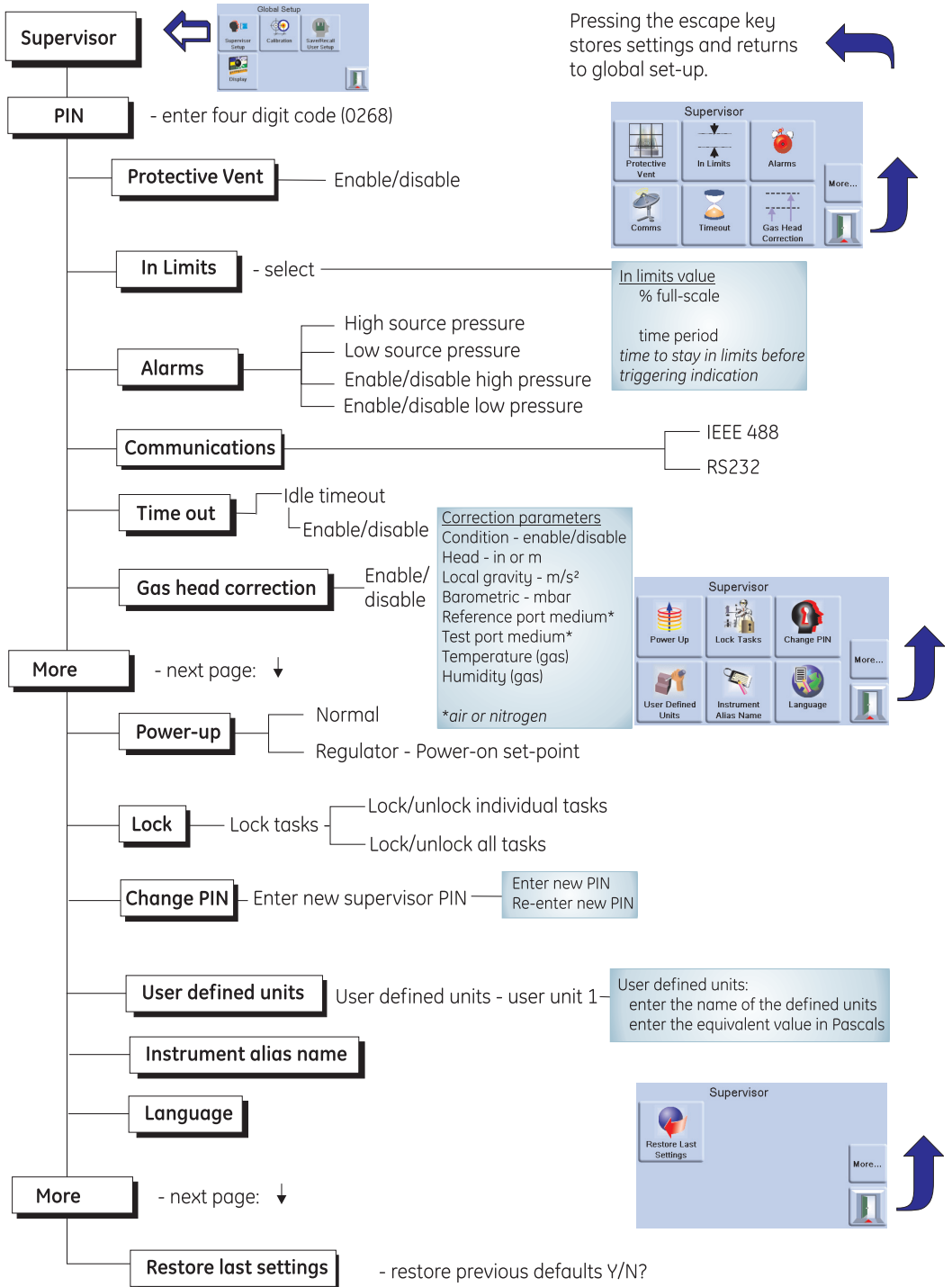

# 3 Operation

## 3.9 Instrument Status

The control set-up menu provides access to the status of the instrument:

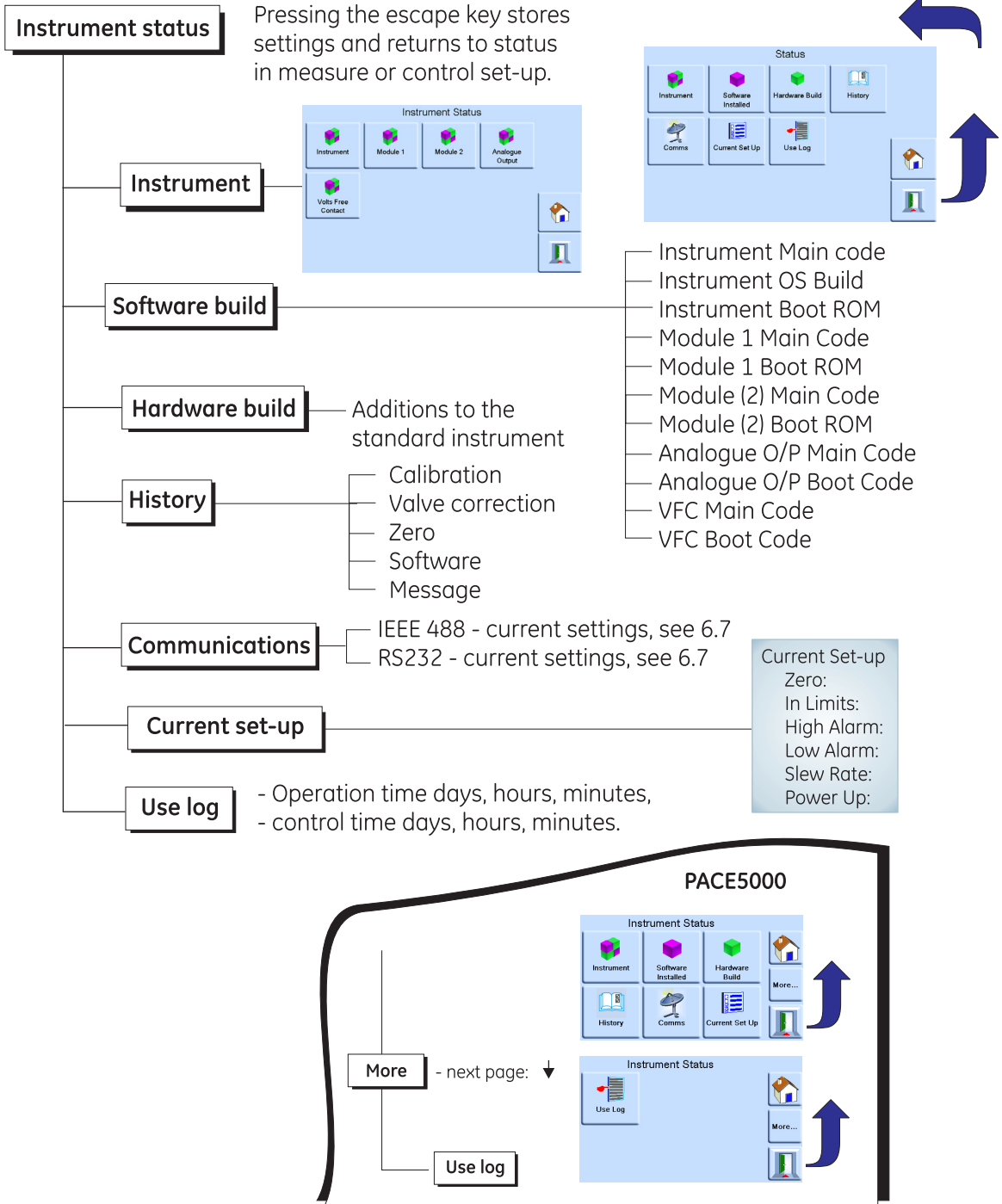

## Software

Software history, in the status menu, provides read only information on the current software in the instrument.

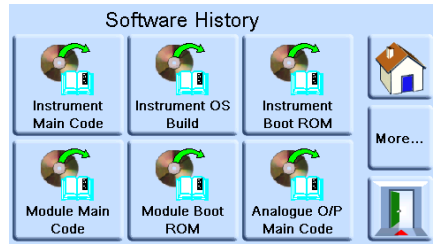
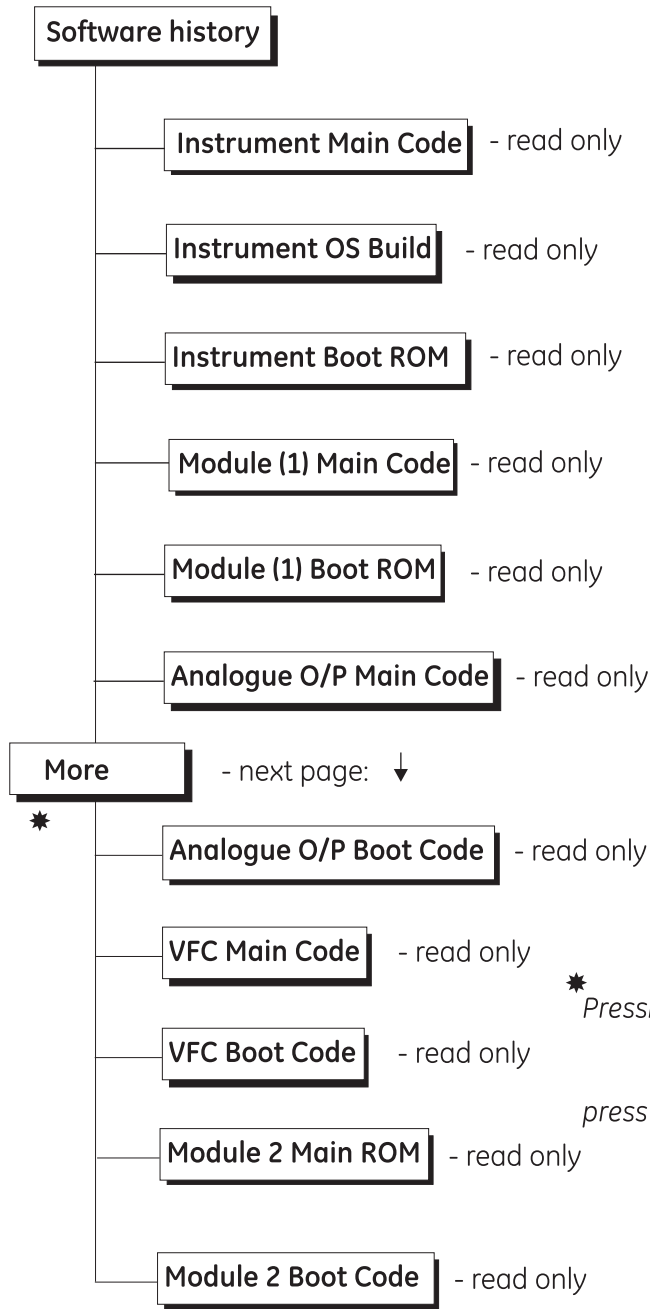

Example

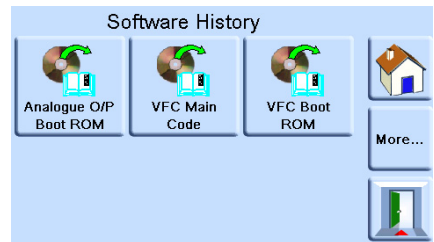
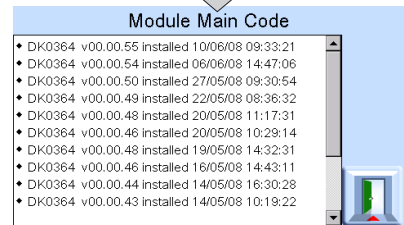

\* Pressing More... returns to the first page

press  to exit set-up.

intentionally left blank

## 4 Maintenance

### 4.1 Introduction

This section contains the routine maintenance and procedures to replace components detailed in Section 5, Testing and Fault Finding and listed in Table 4.2.

**Table 4.1 - Maintenance Tasks**

Task	Period
Visual Inspection	Daily, before use
Cleaning	Weekly*
Test	Before use
Calibration	12 months †
Pressure Module filters	Determined by usage.
Replace Pressure Module	Pressure controller operating hours.

\* may change depends on usage (e.g., rack mounted, bench top) and environment (e.g., humidity, dust).  
† may change depends on the required accuracy.

### 4.2 Visual Inspection

Inspect the external of the instrument, and associated equipment, for obvious signs of damage and dirt. If necessary, clean the instrument as detailed below.

### 4.3 Cleaning

**Caution: Do not use solvents for cleaning.**

Clean the instrument every week. Clean the front panel with a damp lint-free cloth and mild detergent.

### 4.4 Test

Carry out a standard serviceability test, refer to section 5.2.

### 4.5 Calibration

The pressure control module or the complete instrument should be withdrawn from service and returned to the manufacturer or calibration facility, refer to section 6.14.

To find the date of the last calibration, press Measure or Control set-up/Status/Calibration history. Do not use an instrument with out-of-date calibration.

## 4 Maintenance

---

### 4.6 Replacement Parts

Use only the replacement parts listed in Table 4.2.

#### **WARNING:**

**TURN OFF THE SOURCE PRESSURE AND CAREFULLY VENT THE PRESSURE LINES BEFORE DISCONNECTING THE PRESSURE LINES FOR MAINTENANCE. PROCEED WITH CARE.**

**ISOLATE THE INSTRUMENT POWER SUPPLIES BEFORE REPLACING PARTS, WITH POWER APPLIED THE INSTRUMENT CONTAINS LETHAL VOLTAGES.**

**Table 4.2 - Replacement Parts List**

Part number	Description
-	Fuse T2.0A/250V HRC (PACE5000)
-	Fuse T5.0A/250V HRC (PACE6000)
IO-FILTER-KIT	Kit, filter
CMX-XXXX †	Module, pressure control

† refer to data sheet

### 4.7 Fuse Replacement (Fig 4-1)

Replace the fuse when detailed in Section 5, Testing and Fault Finding:

- Set the power switch to OFF.
- Isolate the power supply to the instrument and disconnect the IEC power supply connector (1).

**Note:** *To gain access to rack-mounted instruments, it may be necessary to partially or completely withdraw the instrument. Isolate pneumatic supplies and depressurise all pressure supply inlet and outlet lines.*

- Remove the fuse carrier (2) from the power supply input socket assembly and replace the fuse cartridge (3).

**Note:** *Fit the correct type of fuse detailed in Table 4-2.*

- Refit the fuse carrier (2) in the power supply inlet socket assembly.
- Refit and reconnect rack-mounted units as detailed in Section 2 Installation.
- Switch on the power supply and set the power supply switch to ON. The instrument should now be operational.
- If the fuse blows immediately on switch-on, contact the manufacturer or Service Agent.

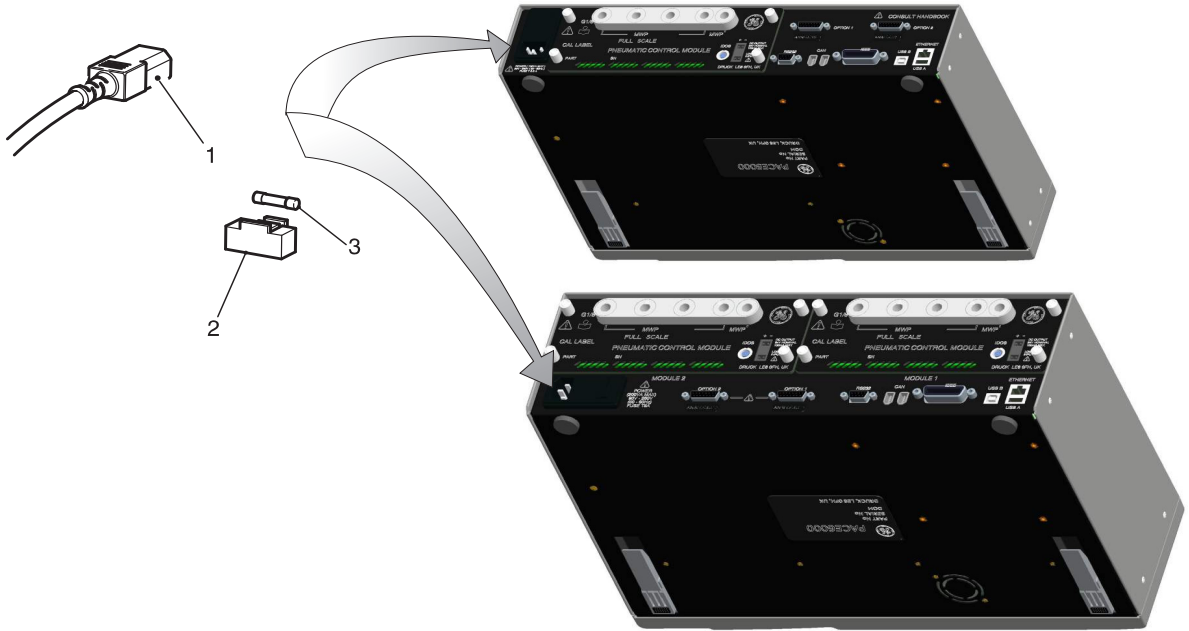

- 1 IEC connector    2 Fuse carrier    3 Fuse

**Figure 4-1, Power Supply Fuse Replacement**

## 4 Maintenance

### 4.8 Filter replacement (Fig 4-2)

When necessary change the filters in the pressure module.

**Note:** *To gain access to rack-mounted instruments, it will be necessary to completely withdraw the instrument from the rack.*

#### Procedure

- Switch off instrument.
- Depressurize the system and isolate the pneumatic supplies.
- Switch off and then disconnect the electrical power supply.
- Disconnect the pneumatic pipes to the pressure module.
- Unscrew the four captive, Phillips cross-head screws securing the pressure module in the instrument case.
- Remove the pressure module to gain access to the filters.
- Using the 5 mm hexagonal key, unscrew the filter retainer (1) in the bore of each of the pressure connection.
- Remove the five filters (2), if necessary, invert the pressure module so that the filters fall out.

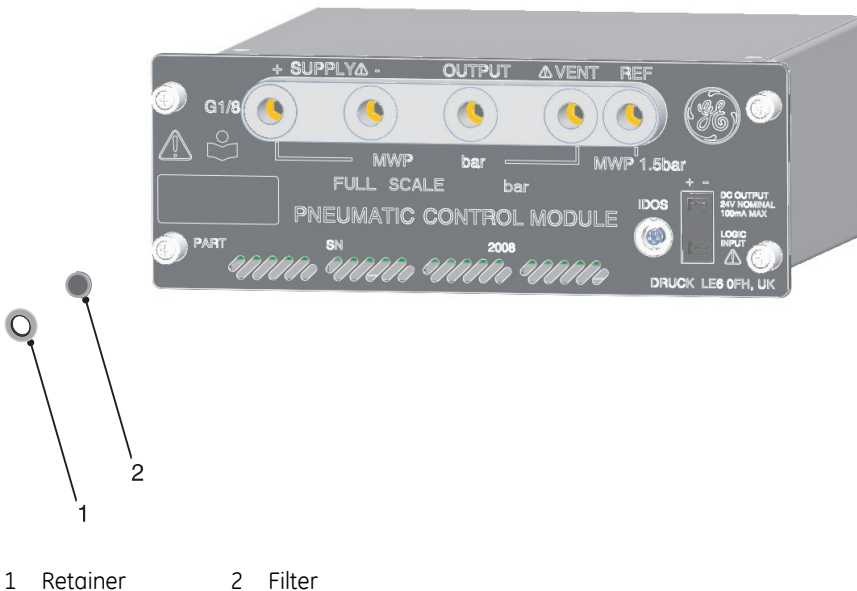

**Figure 4-2 Pressure module filters**

- Insert a new filter in the bore of each of the pressure connection.
- Using the 5 mm hexagonal key, screw in each filter retainer hand-tight.
- Locate the pressure module in the instrument case and secure with the four captive, Phillips cross-head screws.



## 4.9 Pressure module replacement (Fig 4-3)

### WARNING:

TURN OFF THE SOURCE PRESSURE AND VENT THE PRESSURE LINES BEFORE DISCONNECTING OR CONNECTING THE PRESSURE LINES. PROCEED WITH CARE.

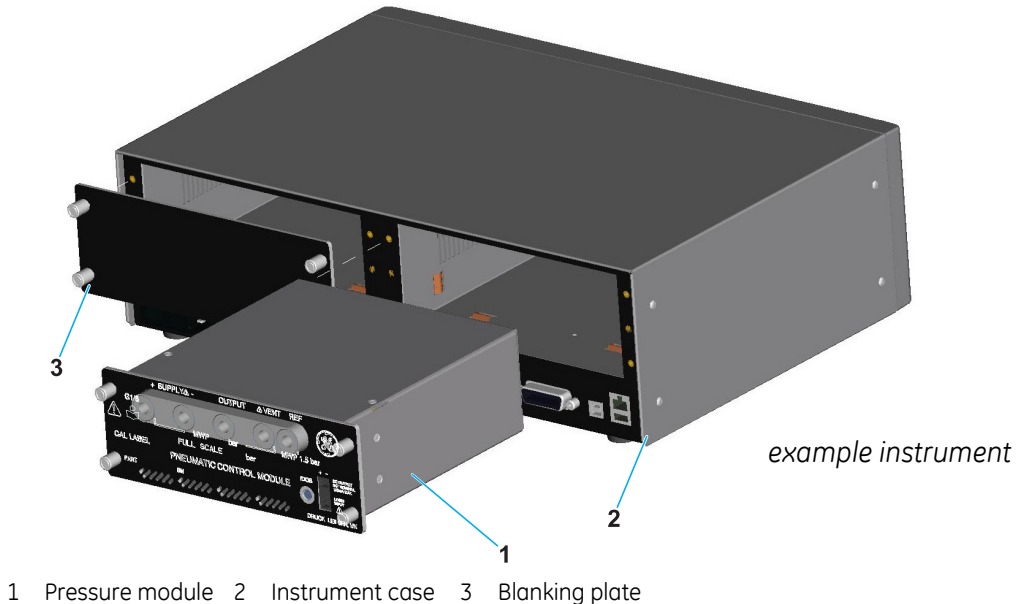

**Figure 4-3 Pressure module**

### Procedure

**Note:** For rack-mounted units, isolate the electrical power and pneumatic supplies. Partially withdraw the unit from the rack to gain access to the electrical and pneumatic connections.

#### Removal

- Switch off instrument.
- Depressurize the system and isolate the pneumatic supplies.
- Switch off and then disconnect the electrical power supply.
- Disconnect the pneumatic pipes to the pressure module.
- Unscrew the four captive, Phillips cross-head screws securing the pressure module (1) in the instrument case (2).

**Note:** If necessary, temporarily fit a blanking plate (supplied) to protect the internal components from ingress of foreign matter.

#### Fitting

- Fit a fully compatible pressure module (1) into the instrument case (2).

**Note:** See below for additional fitting instructions for the PACE 6000.

- Secure the pressure module (1) with the four captive, Phillips cross-head screws.
- Reconnect the pneumatic supplies to the instrument, use appropriate sealing for all pneumatic connections.

## 4 Maintenance

- Reconnect the electrical power supply connector.

**Note:** For rack-mounted units, set the power switch to on, locate and secure the instrument in the rack.

- Apply the pneumatic pressure and/or vacuum supplies - switch on the electrical power supply.
- Switch on the instrument and carry out a serviceability test detailed in section 5.

### PACE 6000

#### Cautions:

1. AFTER REMOVING A CONTROL MODULE, USE A BLANKING PLATE TO KEEP THE FLOW OF COOLING AIR.
2. TWO-CHANNEL OPERATION, COMBINING THE OUTPUTS OF TWO PRESSURE CONTROL MODULES CAN BE DONE WHEN BOTH PRESSURE MODULES ARE BELOW 70 BAR OR BETWEEN 100 TO 210 BAR. DAMAGE OCCURS IF ONE PRESSURE MODULE IS BELOW 70 BAR AND THE OTHER IS 100 TO 210 BAR.

- When installing two pressure modules, the module with the higher pressure range must be located in the right-hand side (Module 1) above the power supply connector.
- If using two pressure modules of the same pressure range, the module with the lower serial number must be located in the right-hand side (Module 1) above the power supply connector.

#### Note:

When connecting the output ports of two pressure modules together make sure both are either:

- below 70 bar.

OR

- between 100 to 210 bar.

To comply with the Pressure Equipment Directive (PED) do not mix these categories.

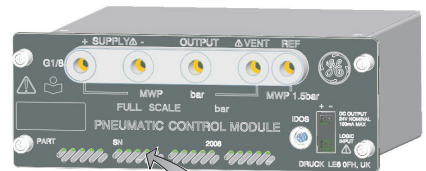

Serial number

## 5 Testing and Fault Finding

### 5.1 Introduction

- The PACE instrument contains a built-in, self-test and diagnosis system that continuously monitors the performance of the unit. At power-up, the system performs a self-test.
- This section details the standard serviceability test. A fault finding table lists possible faults, the probable cause and the procedures to rectify the fault.

### 5.2 Standard Serviceability Test

The following procedure shows if the unit is serviceable and checks functions and facilities of the PACE instrument.

#### Procedure

1. Connect the instrument as detailed in Section 2, Installation. Connect a UUT or fit blanks to the output port.
2. After a successful power-up, select measure set-up and proceed as follows.
  - (a) Select the required units of pressure measurement from the measure set-up menu.
  - (b) Press the status area to enter control set-up and select the required slew rate and vent rate.
  - (c) Press set-point and, using the numeric keys, set a value within the pressure range of the instrument.
  - (d) Check that the screen display shows: the selected units of pressure measurement, the selected type of slew rate and the set-point. Press the **Control** key to start.
  - (e) The screen display changes as follows:
    - The measured pressure digits change from black to blue and shows the pressure value changing towards the set-point.
    - If enabled, the effort meter indicates the work effort of the controller.
  - (f) When the controller achieves the selected pressure set-point, the screen display changes as follows:
    - The colour of the displayed pressure value changes from blue to green indicating that the controller is within the in-limits tolerance.
    - If enabled, the effort meter shows the controller effort to keep the pressure at the set-point.
  - (g) Select vent and the pressure reduces to atmospheric pressure at a controlled rate (vent slew).
  - (h) The test is completed when the controller is at atmospheric pressure.

#### Notes:

1. *The vent opens and remains open until OK is pressed.*
2. *Always use the vent function before disconnecting pressure equipment from the outlet port.*
- (j) The instrument automatically returns to measure mode. The colour of the displayed pressure value changes to black.

After a successful serviceability test the instrument is ready for use.

## 5 Testing and Fault Finding

### 5.3 Fault Finding

Check the fault conditions and solutions listed in the following table before contacting gesensinginspection.com or a recommended Service Agent.

Fault	Solution
Power supply connected, display not lit.	Check rear panel switch set to on. Check fuse and, if necessary, replace Check electrical power supply fuse or circuit breaker.
24 V DC output intermittent.	<u>Internal self-resetting fuse operating.</u> Reduce load current to specified value.
Instruments functions, but does not reach all set-points.	Check pneumatic supplies for correct pressures. Check system for leaks.
In measure mode with output port sealed, the pressure continues to increase or decrease.	Increasing pressure, leaking Apply control valve. Decreasing pressure, leaking Release control valve. Confirm by isolating supplies. Contact approved service agent.
Display pressure reading in red	Over-range, use vent de-pressurize.
Instrument stops in Control mode when controlling at a new pressure.	Idle time-out enabled but timeout period setting too short.
Instrument will not zero, does not achieve set-point.	Blocked vent port. Check for blockage. Contact approved service agent for repair.
Instrument controlling to set-point, no pneumatic output	<u>Blocked isolation valve.</u> Contact approved service agent for repair.
Erratic or inaccurate zero	Leaking isolation valve. Reference port restrictor not fitted. Contact approved service agent for repair.
Increased gas consumption. Unstable control at set-point or does not achieve set-point.	System internal leak. Carry out leak test at full-scale pressure. Contact approved service agent for repair. Reference port restrictor not fitted.

**Table 5.1 - Fault Location**

**Note:** *When the controlled pressure stays within tolerance band the pressure at the outlet is within the limits set in Set-up/Supervisor/In Limits. If the controller status indicator is outside the tolerance band, then this could indicate either a leak in the system or that the supply pressure differs from the pressure for which the control valves have been characterised.*

### 5.4 Approved Service Agents

For the list of service centres  
visit our web site:

[www.gesensinginspection.com](http://www.gesensinginspection.com)

intentionally left blank

## 6 Reference and Specification

### 6.1 Installation notes

The PACE instrument pressure controller/calibrator requires an independent pressure supply and set of connections with the exception of the reference connection; this provides a reference to atmosphere for gauge sensors and barometric sensors.

The instrument must have the correct supply pressure and a suitable supply medium (see data sheet, specification). The supply gas density and type does not affect the accuracy of pressure measurement; assuming that the UUT is at the same level (height) as the controller or gas head correction is accurately set.

#### **Gas supply**

For normal operation the instrument requires a positive supply of at least 110% of range but less than the MWP, with a gas regulator. For absolute operation, negative gauge operation or, if the installation requires a fast response around atmospheric pressure, a vacuum source must be connected to the negative supply (recommended configurations shown in figures 2-3, 2-4 and 2-5). To achieve control performance the source pressure must be maintained at 10% full-scale above the required set-point. Controller performance is maintained during slow variations in source pressure down to a source pressure of 20% full-scale range.

#### **Supply conditioning equipment**

Supplies should be provided with an isolation valve and any other necessary conditioning equipment.

#### **Important note:**

*To protect the control module, for ranges above 100 bar, from over-pressure a suitable protection device (such as a relief valve or bursting disc) must be fitted to limit the applied supply pressure to below the MWP.*

*Should the applied supply pressure exceed the MWP the instrument may indicate this condition by displaying this message.*

#### **Maximum Working Pressure**

If the measured +ve source pressure exceeds the limits below then display a persistent message box as shown.

Clear this message by selecting "OK".

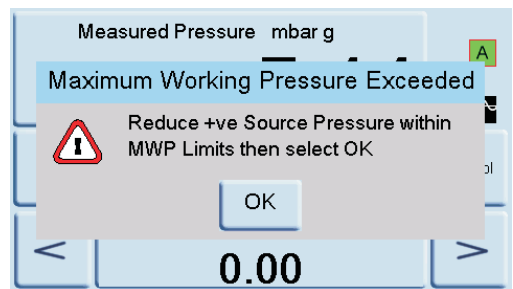

### ***Supply contamination***

Some supplies may need the removal of water, oil or particulate contamination. Any water in the compressed gas supply will be in vapour form, i.e. non-condensing and must be removed using a mist filter. Oil must be completely removed as this causes a rapid deterioration of the control valve performance. The compressed gas supply must not contain particulates and must be removed using a particulate filter. Do not use a compressed gas supply containing corrosive material.

### ***Systems without a negative supply***

Without a negative supply (vacuum pump), release the positive pressure from the system to atmosphere through the negative supply port.

The release from the negative port may be piped away to a place where this discharge causes no disturbance or hazard. Alternatively, a diffuser may be fitted to the negative supply port to diffuse air flow.

### ***The need for a negative supply (for optimum performance)***

#### General

Supply pressures (at least 110% of range but less than the MWP) there must be a difference of 10% of full-scale between the supply pressure and the maximum output pressure. When operating at positive or negative full-scale, there must be a pressure difference between supply and output to cause a gas flow.

#### Operating near atmospheric pressure or below

Any controller operating near atmospheric pressure or below requires a vacuum pump or other negative supply connected to the negative supply port for optimum performance. Without a vacuum supply, as the output pressure approaches atmospheric pressure, the differential pressure approaches zero resulting in a reduced flow to the output.

Reduced flow causes an increase in the time to control to atmosphere, especially with large user volumes, and an increased overshoot at low pressures, see figures 2-3, 2-4 and 2-5.

#### Vacuum Pump

Each PACE Control Module has a vacuum sensor so it is normal practice to connect a vacuum pump to the -ve supply port. The flow rate of the vacuum pump does not matter but generally higher pump flow improves PACE control performance. However, low pressure ranges <700mbar require vacuum regulation or the use of the negative gauge pressure generator IO-NEG-G-GEN-1 option.

### ***Conclusion***

Use a vacuum supply for:

- Absolute ranges
- Negative gauge ranges

A vacuum supply improves:

- Time to reduce system pressure at pressures below 2 bar (30 psi), full-scale.
- Control stability near atmospheric pressure.
- Overshoot at low pressures.
- To improve performance at or near gauge zero.



**Table 6-1 Air Density Values**

Values of air density ( $\text{kg m}^{-3}$ ) for air of relative humidity 50% and containing 0.04% carbon dioxide by volume.

Air pressure (kPa)	Air temperature (°C)						
	14	16	18	20	22	24	26
87	1.052	1.045	1.037	1.029	1.021	1.014	1.006
88	1.064	1.057	1.049	1.041	1.033	1.025	1.018
89	1.077	1.069	1.061	1.053	1.045	1.037	1.029
90	1.089	1.081	1.073	1.065	1.057	1.049	1.041
91	1.101	1.093	1.085	1.077	1.069	1.061	1.053
92	1.113	1.105	1.097	1.089	1.080	1.072	1.064
93	1.125	1.117	1.109	1.100	1.092	1.084	1.076
94	1.137	1.129	1.121	1.112	1.104	1.096	1.088
95	1.149	1.141	1.133	1.124	1.116	1.108	1.099
96	1.162	1.153	1.145	1.136	1.128	1.119	1.111
97	1.174	1.165	1.156	1.148	1.139	1.131	1.123
98	1.186	1.177	1.168	1.160	1.151	1.143	1.134
99	1.198	1.189	1.180	1.172	1.163	1.154	1.146
100	1.210	1.201	1.192	1.184	1.175	1.166	1.158
101	1.222	1.213	1.204	1.196	1.187	1.178	1.169
102	1.234	1.225	1.216	1.207	1.199	1.190	1.181
103	1.247	1.237	1.228	1.219	1.210	1.201	1.193
104	1.259	1.249	1.240	1.231	1.222	1.213	1.204
105	1.271	1.261	1.252	1.243	1.234	1.225	1.216
106	1.283	1.274	1.264	1.255	1.246	1.237	1.228

*Note that 100 kPa = 1 bar*

## 6 Reference and Specification

---

### 6.2 Operational Requirements

#### **Special Note**

**A contaminated UUT must have additional in-line filters connected between the output port and the UUT to prevent contamination of the instrument.**

#### **Negative or Vacuum Supply**

The negative supply for absolute control does not need to be regulated. Any variation between this and absolute zero will affect instrument operation if controlling at low absolute pressures.

#### **Oil Contamination**

Precautions must be taken against oil transfer to the instrument.

#### Recommended

1. A normally-open venting solenoid connected to atmosphere and the pump. When the pump supply is switched off, the valve opens allowing atmospheric pressure to enter the pump directly rather than through the pipe to the instrument.

**Note:** *Without this arrangement, oil may progressively move up the supply pipe and into the instrument.*

#### **Pump Performance**

#### Recommended for ranges above 2 bar (30 psi) gauge, positive full-scale

1. When installing a vacuum supply protect the vacuum pump against the discharge of positive pressure by the controller into the vacuum pump. This may result in reducing vacuum pump performance.
2. Use a check valve in the negative supply to vent excess pressure to atmosphere if the vacuum pressure rises above atmospheric pressure. The check valve should be installed on the instrument side of a volume which is approximately equal to the system volume. The volume slows any rapid pressure rise giving the vacuum pump time to reduce the pressure.

**Note:** *A wide bore vacuum pipe can have enough volume and, used with a check valve, could provide the necessary overpressure protection.*

### **Venting**

Either a zero or vent operation uses the vent port.

#### Vent

The system gas at the output pressure can be released from the vent port. Unrestricted gas flow occurs in this operation.

#### Recommended

Use a controlled method to reduce the system pressure, at a controlled rate, to near atmospheric pressure then select vent.

#### Zero

During a zero operation only the internal volume of the instrument vents to atmosphere.

#### Recommended

Do not obstruct the vent port. To diffuse gas exhaust, a diffuser may be fitted to the vent port.

### **Output port**

The output port provides the controlled test pressure to the unit under test (UUT).

### **Reference Port**

The reference port provides the negative pressure to the gauge sensor and to the barometric reference (option). Gauge sensors use this port identified as "REF". For gauge sensors (without a barometric reference) small pressures can be applied (refer to the MWP stated on the rear panel of the control module). All other pressure measurement requires the port to be opened to atmosphere.

When in gauge mode, the instrument shows and controls the pressure difference between the reference port and the output port.

**Note:** *This is not a true differential operation as there is no true differential calibration of the sensor.*











































The transducer of the barometric reference option senses atmospheric pressure via the reference port, when enabled the port MUST be open to atmosphere.

The reference connection should be actively used (differential connection option) for precision low pressure measurement. The instrument controls pressure relative to the pressure at the reference port. An atmospheric pressure change causes the controller to adjust the pressure and appears at the pressure output as apparent instability. To keep a stable controlled pressure, the reference port should be restricted. Using a reference port restrictor, short term ambient pressure variations can be prevented from affecting controller performance.

The controller and UUT references should be connected together (using the optional differential connection kit ) to provide a common reference to atmosphere.

## 6 Reference and Specification

### 6.3 Icons







Display Icons in Set-up Menus					
Icon	Function	Icon	Function	Icon	Function
	Active		Aero mode		Airspeed range
	Alarm		Altitude range		Area of use
	Asterisk		Auto range		Audio volume
	Auto zero		Backlight		Calibration
	Calibration history		Canbus		Change supervisor PIN
	Communications		Contrast		Control mode
	Copy		Correction analogue output		Correction SCM
	Correction sensor		Correction source sensor		Correction valve
	Current set-up		Date & time		Delete
	Diagnostic analogue OP		Diagnostic barometric option		Diagnostic Canbus
	Diagnostic control sensor		Diagnostic controller		Diagnostic general
	Diagnostic RS232		Diagnostic source sensor		Diagnostic vacuum sensor
	Diagnostic volt-free		Diagnostics		Display
	Divider		Error		Escape

# PACE Pressure Controller User Manual

Icon	Function	Icon	Function	Icon	Function
	Exclamation		Fault history		Gas head pressure
	Gauge mode		Global set-up		Go-to-ground
	Hardware build		Home		Idle time-out
	IEEE488		Information		In limits
	Instrument		Instrument accuracy		Instrument alias name
	Language		Leak test		Lock
	Lock tasks		Logic output		Max-min
	Max peak		Min peak		Nudge
	Passive mode		Percentage		PIN
	Power-up		Preset		Pressure
	Pressure filter		Process		Protective vent
	Question		Range		Recall user set-up
	Reset use log		Resolution		Re-try
	Roughing		RS232		Restore to as shipped settings

## 6 Reference and Specification

Icon	Function	Icon	Function	Icon	Function
	Restore settings 2		Run		Save as shipped
	Save recall user set-up settings		Save user set-up		Screen mode
	Screen saver		SCM filter		SCM zero
	Select range		Set-point disable/enable		Set-point limits
	Set-point higher limit		Set-point lower limit		Set date
	Set serial number		Set time		Set-up zero
	Slew rate linear		Slew rate max rate		Software build
	Software upgrade history		Software upgrade		Status
	Status area		Step (single)		Stop
	Supervisor set-up		Switch test		Tare
	Task		Test program		Test program copy
	Test program delete		Timing		Time out
	Timed zero		Units		User defined units
	Use log		Use log history		Vent

Icon	Function	Icon	Function	Icon	Function
	Vent time out		Vent Yes/No		Vent set-up
	Warning		Zero analogue output		Zero history
	Zero				

## 6.4 Measure Set-up

### **Pressure zero**

During use, the instrument pressure sensor can show small zero shifts caused by time and temperature changes. Regular “zeroing” increases measuring precision.

### **Process**

Selects display processing features that change the reading, as follows:

**%:** Pressure can be expressed as a percentage of full-scale or as a percentage of a specified span.

**Filter:** The reading can be filtered by a custom low pass filter or the filter can be disabled (**default disabled**). The controller works at a speed independent of the filter time constant.

**Tare:** A specific tare value can be selected or the current displayed pressure reading can be “captured” as the tare value. The display shows the selected tare value in the pressure window.

### **Task**

Selecting Task enables a set of pre-determined functions and software enabled optional functions.

### **Units**

Select the new units from the list of pressure measurement units. Special units can also be defined, see supervisor set-up.

### **Global set-up**

See paragraph 6.6.

### **Set-up zero**

Mode = off/auto/timed

Interval = 00.00.00

Isolation status = isolated/non-isolated.

## 6 Reference and Specification

---

### 6.5 Control Set-up

#### **Vent**

Select **Vent** to reduce the system pressure to near atmospheric pressure. Use this feature to reduce system pressure to a safe value before disconnecting the Unit Under Test. Use vent set-up to adjust the slew rate of venting.

**Note:** *The vent key can be selected in the control set-up menu or programmed as an on-screen selection in the status area from the global set-up/ display/status area menu.*

#### **Nudge**

Sets the incremental resolution of the nudge control for trimming the set-point digits.

#### **Set-point Limits**

Defines the limits of pressure that can be entered as a set-point (useful for protecting sensitive UUT).

#### **Slew rate**

Sets how the controller achieves a set-point.

**Linear:** Controller changing pressure linearly to set-point at a rate set by user.

**Note:** *This function should be used for UUT that have hysteresis errors.*

**Rate:** Either maximum rate or at a rate (value) set by user.

**Overshoot:** Fast, changing pressure as fast as possible (may go beyond set-point [overshoot]).

**No overshoot:** changing pressure at an exponential rate but remaining within limits.

#### **Control mode**

Selects one of three modes.

##### Active Control

In this mode, the controller continuously maintains the set-point, compensating for small pressure leaks and thermal affects.

##### Passive Control

In this mode, the user can define a band either side of the set-point, the default band equals to the instrument's precision. When the controlled pressure enters this band, the controller automatically shuts-off. Subsequently, if the measured pressure exits the band, the controller automatically re-establishes the pressure, without instability, the controlled pressure re-enters the band.

**Note:** *If passive mode is in use with a leak free and thermally stable system then the control stability contribution can be discounted from the uncertainty calculation.*

##### Zero Gauge Control

In this mode, the controller switches off once stable at zero gauge and the zero valve opened. Entering a new set-point causes the zero valve to close and the controller starts to control to the new set-point.



## Global set-up

See para. 6.6, not a PIN protected menu.

### Status

The display shows:

- Instrument status, model, module, control sensor, +ve source sensor and -ve source sensor
- Software build - read only data
- Hardware build - read only data
- Calibration history - read only data
- Zero history - read only data
- Communications, IEEE 488 and RS232 are fitted as standard. Additional communication types are options - TBA.
- Current set-up - read only data
- Fault history - read only data
- Software history - read only data
- Use log - read only data

### Vent set-up

Use the vent set-up to prevent damage to rate-sensitive equipment connected to this controller. The vent slew rate setting is independent of the controller slew rate settings.

## 6.6 Global set-up

### Supervisor set-up

PIN protected menu.

### Calibration

PIN protected menu.

### Save/recall user set-up

Save user set-up

Recall user set-up

### Display -

Resolution

Backlight

Audio volume

Status area

## 6 Reference and Specification

---

### 6.7 Supervisor Set-up

The Supervisor menu provides facilities for programming settings. These are usually made during installation as follows:

#### **Important Note:**

*A PIN protects the Supervisor menu against unauthorised use. Each instrument on delivery contains the factory set PIN (0268). To continue protecting the supervisor set-up menu the PIN should be changed as soon as possible.*

#### **Protective Vent**

The protective vent can be enabled or disabled and causes the discharge of pressure at a controlled rate if the measured pressure exceeds 110% full-scale. This protects the pressure sensor from over-range.

#### **In Limits**

A tolerance value can be set at the set-point. When the controller achieves the set-point, the instrument controls within this set tolerance value. It does not affect controller stability or precision. The instrument uses the 'in limits' flag when performing a control task such as Leak Test or Switch Test.

**Note:** *In remote control, the control computer can be used to interrogate the 'in limits' register to confirm the controller has achieved set-point.*

#### **Alarms**

One or two pressure alarms can be set. An alarm triggers when the pressure exceeds the high alarm or falls below the low alarm. A buzzer sounds when the alarm triggers and the alarm symbol (bell) appears on the display.

#### **Comms**

Selects a communication port and parameters for simultaneous operation of both the RS232 and the IEEE 488 interfaces.

The user can select appropriate settings for communicating with the control computer (PC) and the required command protocol. Refer to publication K0472, SCPI Remote Communications Manual or K0469 Heritage Communications Manual.

#### RS232

Located on the rear panel an external RS232 connection requires:

Connector	=	9-way 'D' female wired as per Table 2-1
Communications	=	RS232 point-to-point only (DPI 520 daisy chain is not supported)
Baud Rate power-up default	=	9600, no parity & handshake = xon/xoff.
Baud rates selectable **	=	2400, 4800, 9600, 19k2, 38k4, 57k6 & 115k2
Parity	=	None, Odd & Even
Flow control	=	None, Hardware & xon/xoff
Protocols	=	SCPI, DPI 520, DPI 500
New data up-date rate	=	refer to data sheet

\*\* *Selectable through the user interface.*

Built-in EMC Filtering and Transient voltage protection.

# PACE Pressure Controller User Manual

---

## IEEE 488

Located on the rear panel an external IEEE 488 connection requires:

Connector	=	24-way 'D' female wired as IEEE 488 standard
Communications	=	IEEE 488 GPIB
Default Address	=	16
Protocols	=	SCPI, DPI 520, DPI 500
New data up-date rate	=	refer to data sheet

Built-in EMC filtering and transient voltage protection.

## Timeout

Presets the times for automatically changing from control to measure mode.

**Note:** *Controller timeouts can save supply gas, extending control valve life and minimising acoustic noise.*

**Idle Timeout** starts when the controller achieves the set-point after the set time, if new set-points are not entered the timer will time-out and return to measure mode.

## Gas Head Correction

Corrects pressure output for the height difference between instrument and UUT:

- for UUT positioned higher than the reference level of the PACE instrument enter a positive height correction.
- for UUT positioned lower than the reference level of the PACE instrument enter a negative height correction.



When calibrating the PACE instrument disable the gas head correction and correct the actual applied pressures for height.

## 6 Reference and Specification

---

### **Power Up**

With Normal selected, the instrument powers up in **Measure** mode.

With power-up set-point selected, the instrument powers-up in **Control** mode at a pre-selected set-point value.

**Note:** *When using power-up set-point, be sure to disable the **Idle Timeout** feature.*

### **Lock Tasks**

#### Individual tasks:

Allows any combination of individual tasks to be disabled.

**Note:** *Restricts operation of the instrument to specific tasks or functions, ideal for production procedures.*

#### All:

Disables all tasks.

### **Change PIN**

Changes the Supervisor PIN: enter the existing PIN, then the new PIN and confirmation of the new PIN.

**Note:** *Confirmation of the new PIN permanently replaces the old PIN. Record this new PIN and keep this record on a safe place. Should this new PIN become lost it can only be reset by returning the instrument to a GE service centre.*

### **User defined units**

Permits the user to define a set of units. Following the on-screen prompts special units may be set by selecting a Pascal multiplier and assigning a five character name.

### **Instrument alias name**

Permits the user to define a 20 character alias name for the instrument. The instrument returns this name through the communications interfaces.

### **Language**

Operation in any of the following languages can be selected: English (default), French, German, Italian, Portuguese, Spanish, Russian, Chinese, Japanese.

*Further languages can be added.*

### **Restore as shipped settings**

Restores instrument settings to factory default.

**Note:** *Does not affect PIN settings.*

## 6.8 Options

### Options in the Task Menu

The following software enabled options can be selected from the task menu:

#### Leak Test option

This task applies one or two test pressures to either an external system to find any leaks in a system connected to the instrument or an internal leak check. This task sets the test pressure, control dwell time at the test pressure and the leak test time (measure dwell time).

At the start of the test, the instrument applies a test pressure to the user system.

A control dwell time allows the user system to thermally stabilise. The instrument changes to measured mode and then records the pressure change during measure dwell time. On completion, the display shows the leak rate results with leak rates per second or per minute in the current pressure units selected in measure set-up.

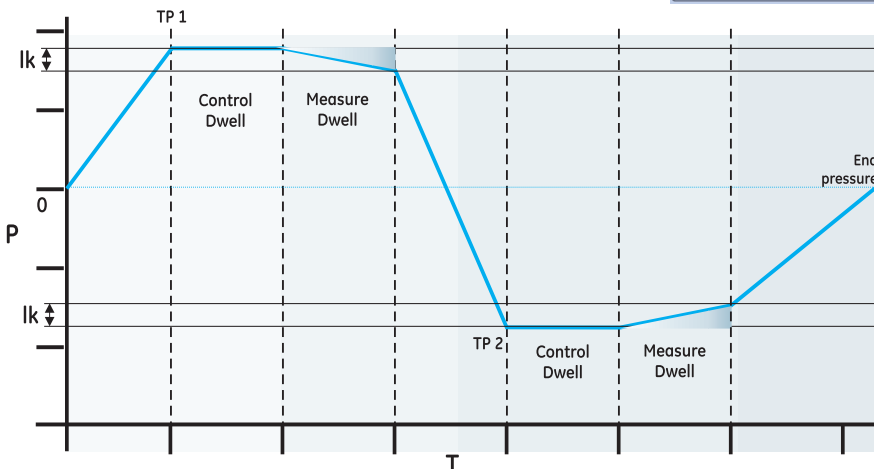
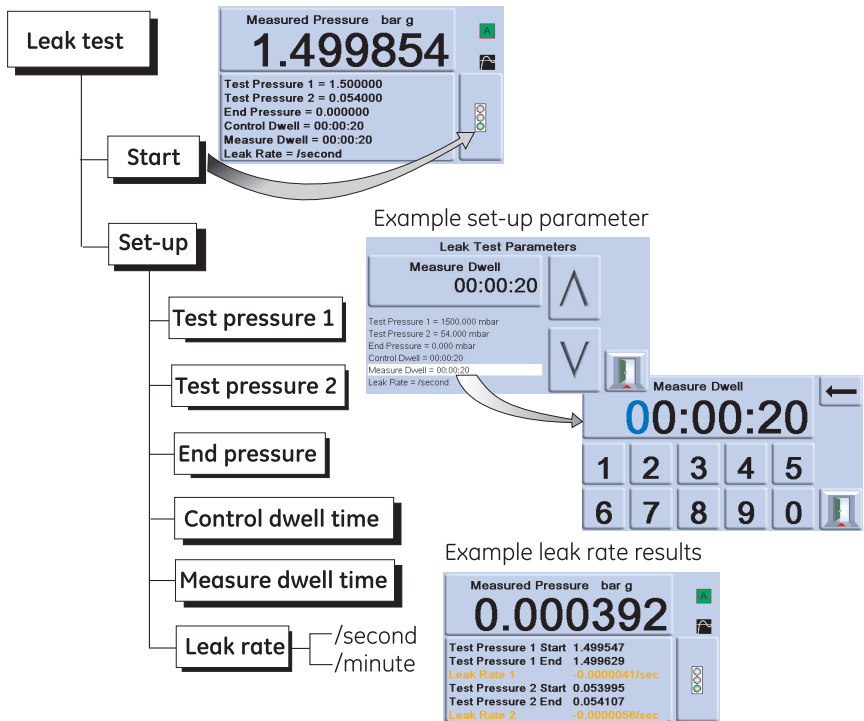

lk = leak P = pressure T = time (seconds) TP = test pressure

## 6 Reference and Specification

### Switch Test option

This function automates the testing of pressure switch devices. Connect the pressure port of the switch to be tested to the output port. Connect the switch contacts in series with the 24V dc output and the Logic Input.

**Note:** The volt-free logic input connections require a switching potential (24V max) to be applied. If necessary, this can be an external d.c. source. Common mode must be kept within 30 V maximum.

#### Start

Controls pressure at a fast slew rate to a set-point just below expected switch operating point. De-bounce time can be increased for slower test slew rates.

#### Test

Controls pressure between two set-points and, if required, can repeat (loop) n times and auto-reverse can be selected.

#### End

Controls pressure to a safe condition to disconnect switch under test.

### Procedure

Select the switch test parameters in the switch test menu, including the start pressure, end pressure and test rate of change. Slower rates give more accurate results. The de-bounce time can be set between 0 and 200 ms.

After the test, the display shows the pressures at which the contacts open and close and the switch hysteresis (the difference between the two switching pressures).

Before disconnecting the switch under test, press **Release pressure** to release any residual pressure.

**Note:** This switch test procedure can be repeated to "exercise" the switch unit. Logic input is opto-isolated. An external supply (5V to 24V)  $\approx$  can be used provided its' common mode voltage remains with 30 Vmax with respect to chassis

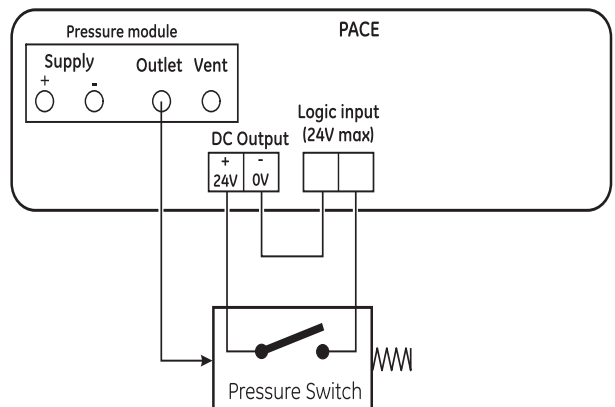
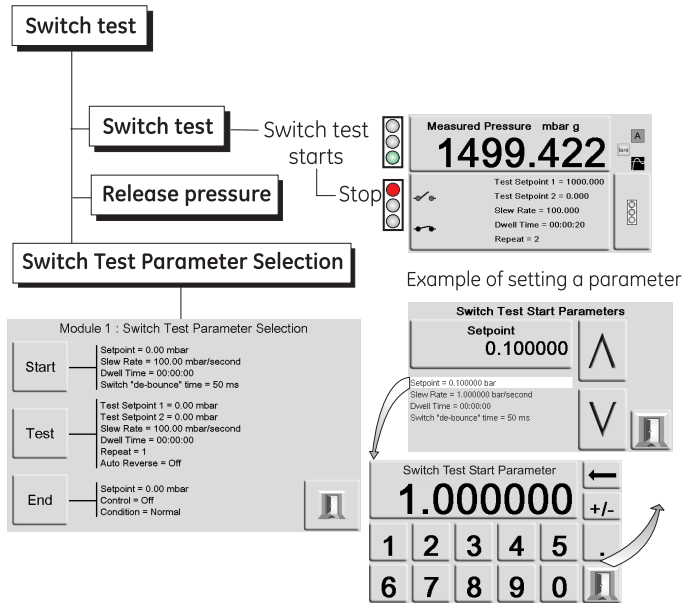

**Example Switch Test Connections**

## Test Program option

The test program task provides a facility for writing and executing test procedures. Selecting a test program from the Task menu displays all the task programs currently stored, together with the ability to write new ones.

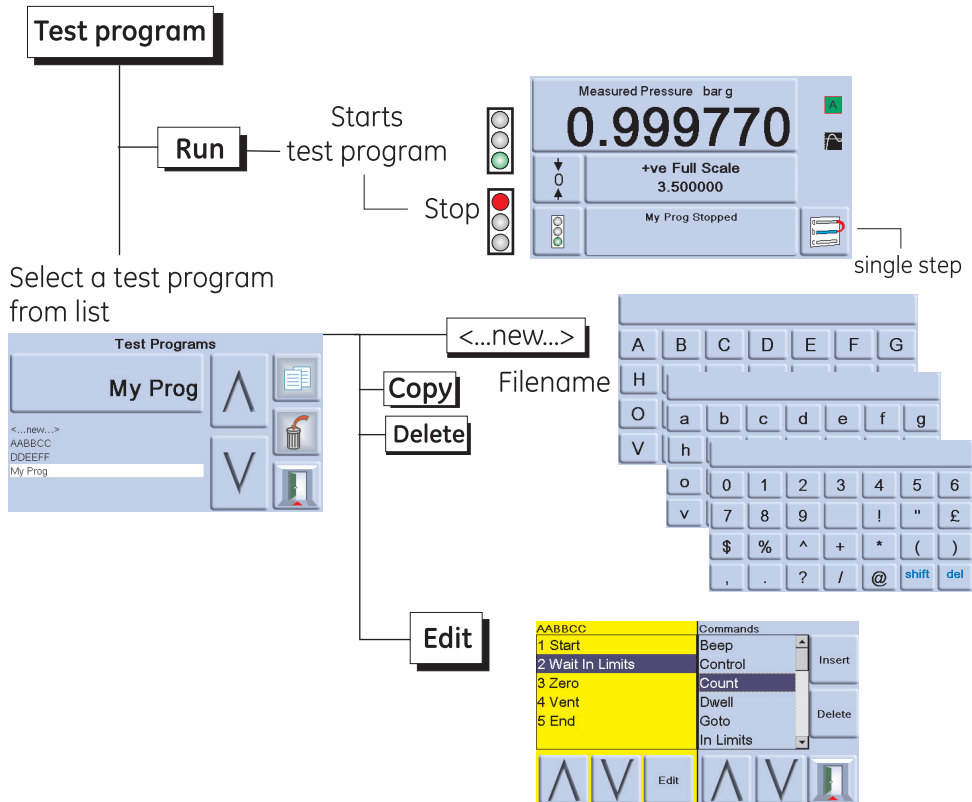

## 6 Reference and Specification

### Program

To start a test program, select the test programs listed on the screen, the step function moves down the list of available test programs. To start a test program, press run.

When the program starts, a stop legend replaces the run legend. Press the stop key at any time to stop the test program.

- To write a test program, press Set-up and select New.

**Note:** A new test always contains a START and END command (first and last line instructions), these lines cannot be deleted.

- To edit an existing program, press Edit.
- Enter a name for the program using the text editor keys to select letter range to select the letter within the range. Use the right arrow key to move to the next character position.
- Press enter on completion.
- The display shows the line instruction with insert and delete selections. Pressing insert changes the display to a list of the available programming commands.

**Table 3.1 - Test Program Commands**

Command	Description	Command	Description
BEEP	Beep on/off.	RATE_VALUE	Specifies controller rate.
BREAK	Breaks to this point when stop count command or STOP icon is selected, then executing code to the end.	RESOLUTION	Sets display resolution.
CONTROL	Selects Control mode.	SETPOINT	Allows set-point to be entered.
COUNT	Used in a loop to count the number of loop cycles.	SETTLING_FAST	Used to specify overshoot requirements.
DWELL	Specifies dwell time (seconds).	SETTLING_N_O	Used to specify no overshoot.
GOTO	Used to set-up a loop. Enter program line number to go to.	STOP_COUNT	Used to stop loop program after a number of loops.
IN_LIMITS	In_Limits band setting (% full-scale).	TEXT	Sets screen message.
IN_LIMITS_TIME	Waits, within In_Limits for this time period, before setting a valid In_Limits condition.	UNITS	Selects required display units.
IP_LOGIC	Specifies change of state for external contacts as a halt condition.	VENT	Instructs instrument to vent.
MEASURE	Selects Measure mode.	VFC OFF	Sets VFC allocation test program off.
PAUSE	Causes test program to pause for user input (Resume)	VFC ON	Sets VFC allocation test program on.
RANGE	Specifies instrument range	WAIT_IN_LIMITS	Waits until pressure is within the limits.
RATE_MAX	Sets controller rate to maximum.	ZERO	Output zeroed"

To select a command, use the command on the display and press insert key to write it into the program. Place the UNITS, RATE, SETTLING and RESOLUTION commands at the start of the program this protects pressure-sensitive UUT.

When selected, certain commands require a value or selection to be set (e.g.) RANGE, RATE, TEXT the display shows a screen prompt for the appropriate setting.



## PACE Pressure Controller User Manual

---

### Example Program

**Note:** Changes to instrument settings made in a test program remain valid only for the test program. The instrument reverts to the pre-test settings on completion.

Step	Command	Argument	Action
	START		Program start
1	UNITS	mbar	Select units, mbar
2	RATE	100	Select rate, 100 mbar/min
3	IN LIMITS TIME		10 (00:00:10) secs
4	IN LIMITS		Set In Limits Band
5	RESOLUTION	5	Display resolution, 5 digits
6	SETTLING		No overshoot
7	TEXT		Operator instruction, e.g. "Connect UUT"
8	ZERO		
9	SET-POINT	400	Set-point, 400 mbar
10	CONTROL		Controller ON
11	WAIT IN LIMITS		Wait for In Limits Condition
12	BEEP		Beep on, approx. 1 sec, Beep off
13	MEASURE		Switch to Measure (controller off)
14	DWELL	30	Wait for 30 sec (00:00:30)
15	SET-POINT	800	Set-point, 800 mbar
16	CONTROL		Controller on
17	WAIT IN LIMITS		Wait for In Limits Condition
18	BEEP ON		Beep on, approx. 1sec, Beep off
19	MEASURE		Switch to Measure (controller off)
20	TEXT		Operator instruction, e.g. (Wait for beep, record pressure)
21	DWELL	30	Wait for 30 sec
22	BEEP		Beep on, approx. 1 sec, Beep off
23	TEXT		Operator instruction, e.g. "Min pressure allowed 785 mbar"
24	PAUSE		WAIT, (for operator input to touch single step)
25	VENT		Vent
	END		Program end

## 6 Reference and Specification

---

### **Programming Loops**

To program a loop, use the GOTO command. Include the COUNT command in the loop for counting the number of loop cycles.

**Note:**

*The test program commands do not include tests for conditional jumps; to stop a test program from looping, **Stop** must be selected by the operator.*

### **Example of programming a loop**

	START		<i>Program start</i>
1	UNITS	mbar	<i>Select units, mbar</i>
2	RATE_VALUE	100	<i>Select rate 100mbar/min</i>
3	RESOLUTION	5	<i>Display resolution 5 digits</i>
4	IN LIMITS		<i>Sets the In-limits band</i>
5	IN LIMITS TIME		<i>10 (00:00:10) secs</i>
6	SETTLING_N_O	zero	<i>No overshoot</i>
7	TEXT		<i>Operator instruction, e.g. "Connect UUT"</i>
8	ZERO		<i>Performs a sensor zero</i>
9	SET-POINT	400	<i>Set-point, 400 mbar</i>
10	CONTROL		<i>Controller ON</i>
11	WAIT IN LIMITS		<i>Wait for In-limits condition</i>
12	BEEP ON		<i>Beep on, approx. 1sec, Beep off</i>
13	MEASURE		<i>Switch to measure (controller off)</i>
14	DWELL	30	<i>Wait, 30 sec</i>
15	SET-POINT	800	<i>Set-point, 800 mbar</i>
16	CONTROL		<i>Controller on</i>
17	WAIT IN LIMITS		<i>Wait for In-limits condition</i>
18	BEEP ON		<i>Beep on, approx. 1sec, Beep off</i>
19	MEASURE		<i>Switch to measure, controller off</i>
20	COUNT		<i>Increment loop counter</i>
21	VENT		<i>Vent</i>
22	GOTO	9	<i>Loop back to program line 9</i>
	END		<i>Program end</i>

## Barometric Reference Option

The barometric reference option measures the barometric pressure at the reference port. When installed, this option allows absolute or gauge pressure range selection. To obtain absolute pressure the instrument uses a summation of gauge pressure and barometric pressure (measured by the barometric sensor).

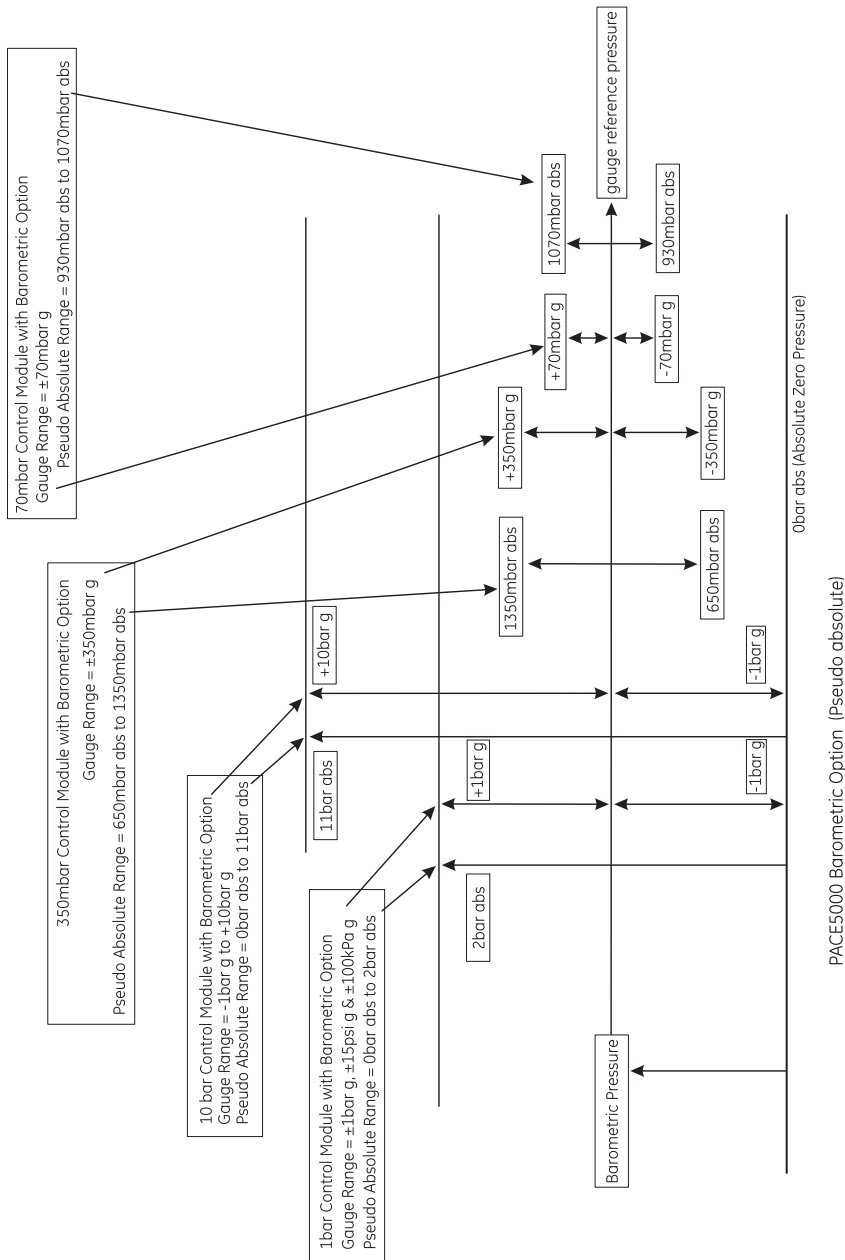

Refer to SDS 0001 or SDS 0008 for the performance of barometric reference and precision of absolute ranges.

## 6 Reference and Specification

### Aeronautical option

The aeronautical option is a specialised application of the PACE instrument.

#### Special application note:

*The PACE instrument must be set-up very carefully so that the aeronautical pressures applied do not exceed maximum pressure values and rates of change.*

#### Leak testing

##### Cautions:

1. **Do not exceed the maximum pressures stated in the appropriate Component Maintenance Manual for the unit under test.**
2. **Carefully de-pressurize all pipes to atmospheric pressure before disconnecting and connecting to the unit under test.**

Before testing an aeronautical component carry out a leak test. This task sets the test pressure, dwell time at the test pressure and the leak test time.

At the start of the test, the instrument applies a test pressure to the user system. A dwell time allows the user system to stabilise.

#### Aeronautical testing

The aeronautical task enables control and measurement of altitude and airspeed in aeronautical units such as feet and metres (altitude) and knots, mph, km/h (airspeed). This task utilises dual pressure displays to show the parameter and the rate of change of Altitude, Airspeed, Mach and Airspeed with Mach number.

The aeronautical task enables the testing and calibration checking of aeronautical indicators and system components by controlling and displaying values and rates in aeronautical units.

When using a single instrument, the pressure supply must be changed when changing from Altitude to Airspeed.

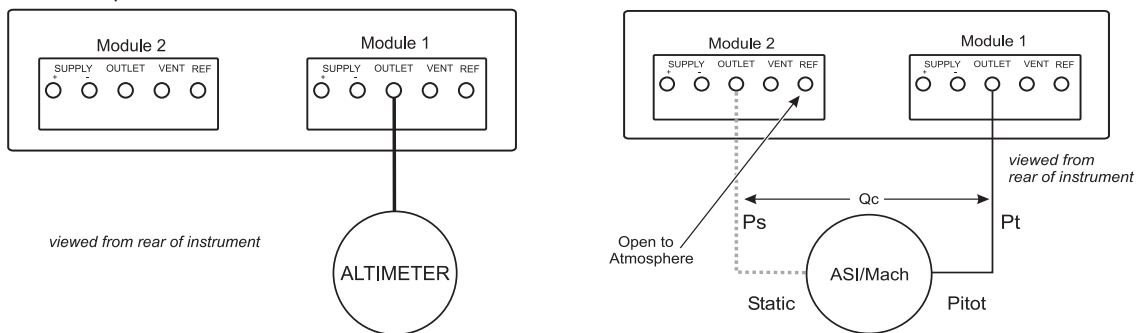

# PACE Pressure Controller User Manual

## Example of Altitude and Airspeed Testing

This example shows how two-channel PACE instruments can be used to generate altitude and airspeed.

### Cautions:

1. Before testing, set the rates of change for both Pitot and Static to a safe value. A high rate of change can damage sensitive aeronautical components. Refer to the appropriate Component Maintenance Manual for the unit under test.
2. In this example configuration, negative airspeed can be generated this can damage an airspeed indicator. To prevent negative airspeed, apply the static pressure before the pitot pressure for increasing and decreasing airspeed values.

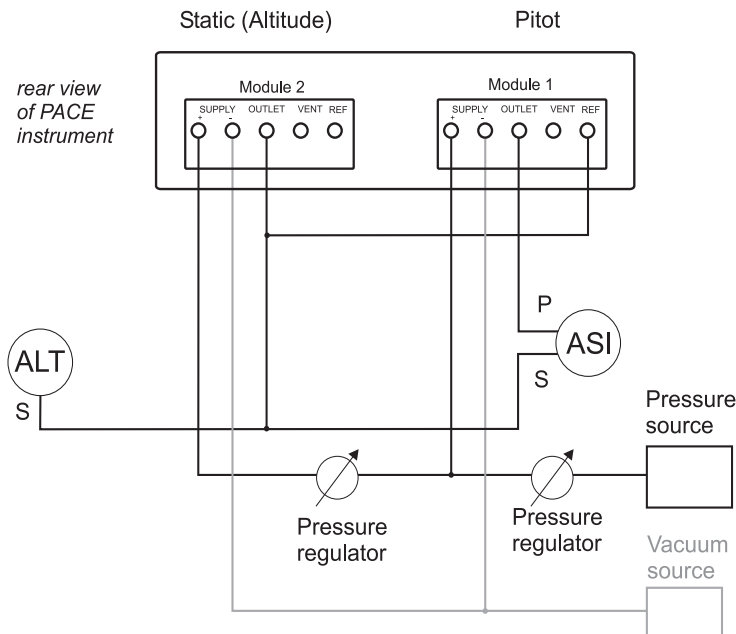

### Units

- The units can be either the aeronautical or pressure units. At any time, the units can be changed between pressure and pressure converted to aeronautical units. The display shows the outlet pressure converted to Altitude, CAS or Mach using BS 2G 199:1984\* conversions and assuming standard atmospheric conditions.

\* Based on tables from ICAO Standard Atmosphere 1964.

### Reference Pressure

- Select the required reference pressure, this can be either the barometric pressure (from the instrument's internal barometric sensor), or any numeric value (e.g.) 1013.25 mbar.

### Go to ground

- Returns the instrument and any unit under test (UUT), connected to it, safely to ground pressure at a controlled (timed) rate.

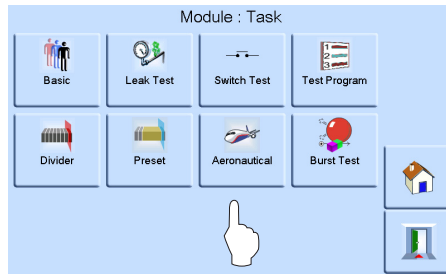

In the aeronautical mode, the display goes to the last selected parameter (altitude, airspeed or Mach).

**Altitude**

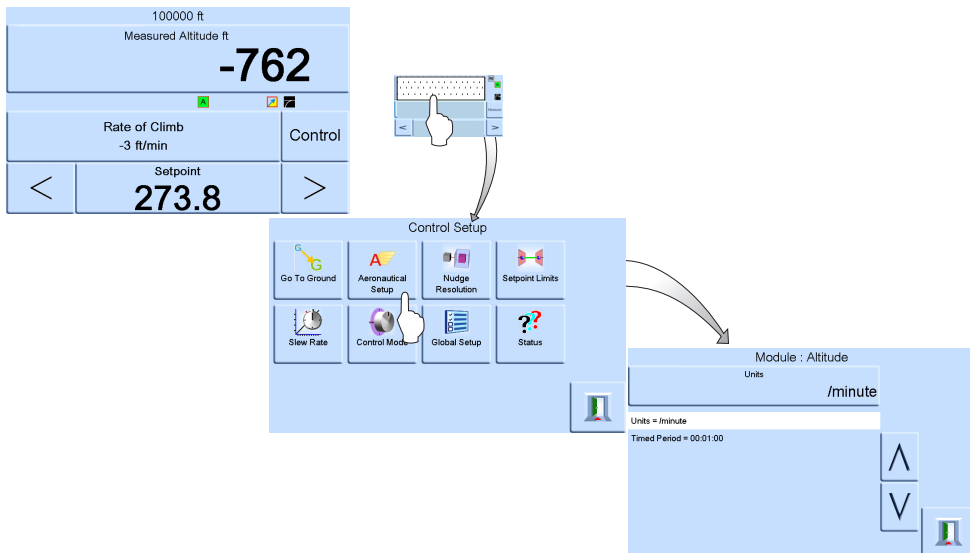

# PACE Pressure Controller User Manual

## Airspeed

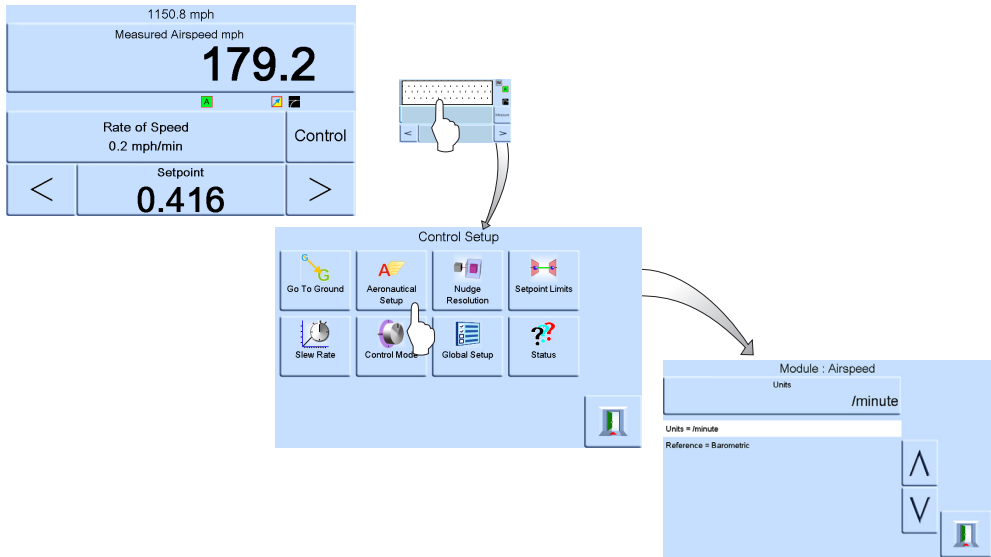

## Mach

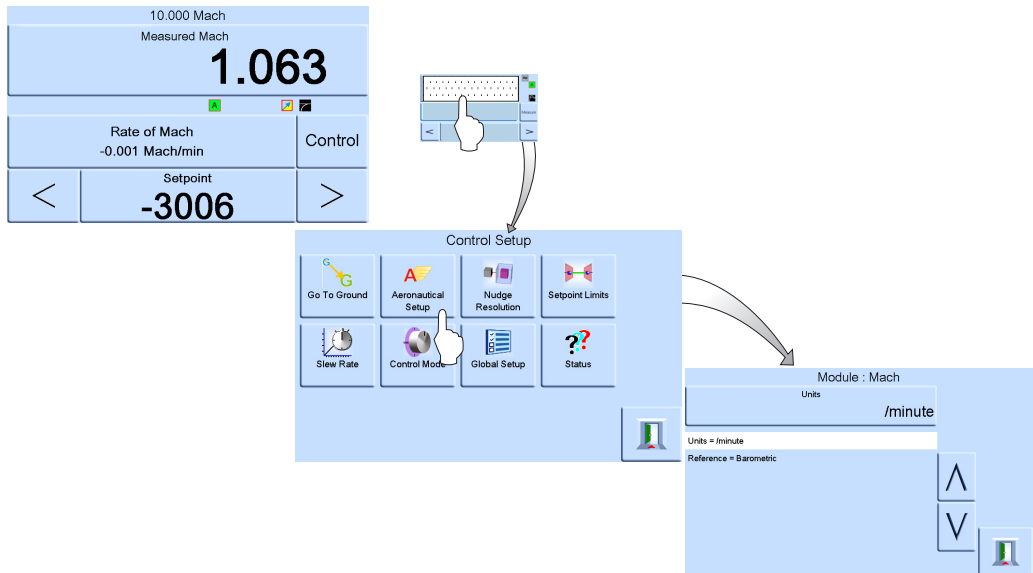

## 6 Reference and Specification

### Analogue Output Option

The analogue output option provides a selectable output of voltage or current.

*Selects Analogue O/P range.*

Analogue O/P Setup

0 to 10V

0 to 10V (Off)  
0 to 5V  
-5 to +5V  
4 to 20mA  
0 to 20mA

*On/off*

Analogue Output : 4 to 20mA

Condition Off

Condition = Off  
4mA = 0.0 mbar  
20mA = 0.0 mbar  
Update Rate = 10 readings/sec

*Update rate of Analogue O/P option from the control module.*

Analogue Output : 4 to 20mA

Update Rate 10

Condition = Off  
4mA = 0.0 mbar  
20mA = 0.0 mbar  
Update Rate = 10 readings/sec

Update Rate

Out of Range  
Upper Limit = 80  
Lower Limit = 2  
Please Retry or Cancel

1 2 3 4 5  
6 7 8 9 0

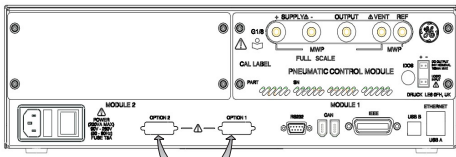

analogue connections

30V<sub>max</sub>  
30V maximum with respect to chassis

Analogue O/P bandwidth = 0.5 x update rate (Hz)



## Volts-free Contact Option

The Volts-free Contact option provides a selectable output of voltage or current.

Each selection has three VFC.

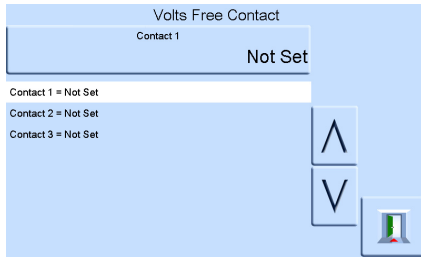

Selection of trigger conditions

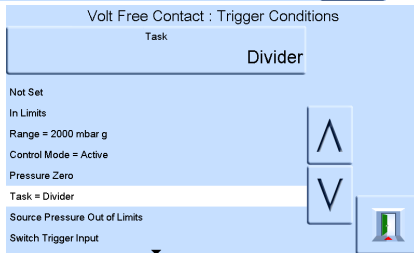

Selection of trigger conditions

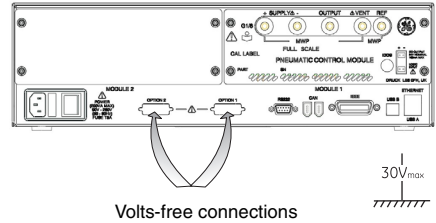
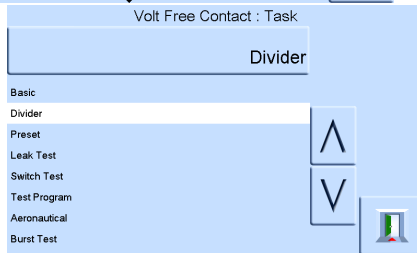

Volts-free connections

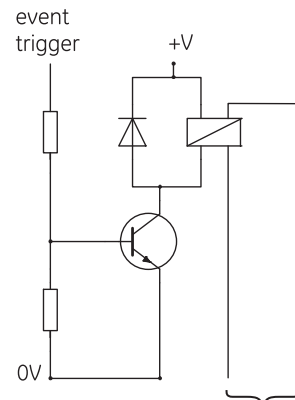

24 V d.c. maximum  
30 V d.c. wrt chassis  
1A resistive maximum

Volts-free schematic

## 6 Reference and Specification

---

### 6.9 Calibration

The calibration menu provides facilities for programming settings for maintenance as follows:

**Note:** *A PIN protects the Calibration menu against unauthorised use. Each instrument, on delivery, contains the factory set PIN (4321). To continue protecting the supervisor set-up menu, the PIN should be changed as soon as possible.*

**+ve source zero**

**-ve source zero**

**sensor correction**

- Selects the range for a three-point calibration routine.

**valve correction**

**source PDCR correction** - three-point calibration of both source pressure sensors

**screen calibration**

**Time & Date**

- Sets instrument clock and calendar.

**Change PIN**

- Changes the Calibration PIN. Enter the existing PIN, the new PIN and confirmation of the new PIN. *Should this new PIN become lost it can only be reset by returning the instrument to a GE service centre.*

### Option enable process

Use the following process to enable the test program option on a PACE instrument.

*Example*

- Touch the top Measure area of the screen.
- Select Global Setup.
- Select Calibration.
- Enter a Calibration PIN of 1234.
- Enter new option key xxxxxxxxxxxx (10 digits).
- After entry of this key PACE confirms the options have been enabled.

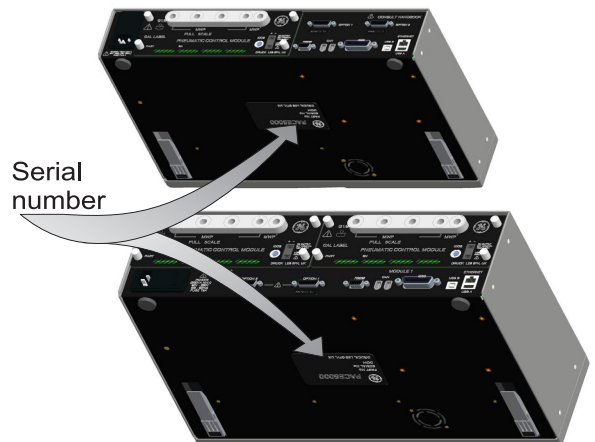

### 6.10 Communications - Instrument Emulation

Refer to PACE Communications Manual - Instrument Emulation, K0469.

### 6.11 Specification

Refer to the PACE 5000 datasheet or PACE 6000 datasheet for details.

**Note:** *The data sheet SDS 0001 or SDS 0008 is contained in the CD shipped with the product.*

### 6.12 Return Goods/Material Procedure

Should the unit require calibration or become unserviceable it can be returned to the nearest GE Service Centre listed at [gesensinginspection.com](http://gesensinginspection.com).

Please contact our Service Department, either by 'phone, fax or E-mail, to obtain a Return Goods Authorisation (RGA) or in the USA, Return Material Authorization [RMA], providing the following information:

Product (i.e. PACE instrument)  
Serial number  
Details of defect/work to be undertaken  
Calibration traceability requirements  
Operating conditions

### Safety Precautions

You must also tell us if the product has been in contact with anything hazardous or toxic and, the relevant COSHH or in the USA, MSDS, references and precautions to be taken when handling.

### Important notice

Service or calibration by unauthorized sources will affect the warranty and may not guarantee further performance.

## 6 Reference and Specification

---

### 6.13 Packaging Procedure

- 1 The instrument should be at zero/ambient pressure. Set the power switch to off. Shut off the pneumatic pressure and vacuum supplies to the instrument.
  - Switch off and isolate the electrical power supply to the instrument. Remove the instrument from the equipment rack to access the rear panel.
  - Disconnect the power supply cable and the pneumatic supply hose assemblies.
  - Stow the power supply cable in the packaging below.
  - Remove any pressure adaptors, diffusers and restrictors.
  
- 2 If available, use the original packing material. When using packing materials other than the original, proceed as follows.
  - Fit protection to all the ports to prevent ingress of moisture and dirt.

**Note:**        *Use the original red plastic plugs or low tack masking tape.*

  - Wrap unit in polyethylene sheeting.
  - Select a double-wall cardboard container. Inside dimensions must be at least 15 cm (6") greater than the equipment. The carton must meet test strength requirements of  $\geq 125$  kg (275 lbs).
  - Protect all sides with shock-absorbing material to prevent equipment movement within the container.
  - Seal carton with approved sealing tape.
  - Mark carton "FRAGILE" on all sides, top, and bottom of shipping container.

#### **Environment**

- The following conditions apply for both shipping and storage:  
Temperature range         $-20^{\circ}$  to  $+70^{\circ}\text{C}$  ( $-4^{\circ}$  to  $+158^{\circ}\text{F}$ )



